



Find out about Tixall Gatehouse's past...

Hello, welcome to Tixall Gatehouse. My name is Eddie Aston. I lived in a big house called Tixall Hall; it was just behind where the Gatehouse stands now (not the one that's there now, though!) My dad built Tixall Gatehouse when he **inherited** the Tixall lands in 1568. He was very important and fought in lots of battles. He was so brave in one battle fighting the French up in Scotland that Queen Elizabeth I knighted him. Good thing her hand didn't slip when she was holding the sword!



Dad loved to show off how rich and important he was, that's why he built the gatehouse. We had big parties and the guests stayed in the gatehouse. They were so impressed by it, especially all the stone carvings. If it was my gatehouse I'd have dragons carved into the stone, not angels! What would you have carved?

.....

Fact:

Inherited means when someone dies (normally your parents) you get their property, lands and money.

My favourite parties were when we'd go hunting. Lots and lots of important men came for the hunt. We'd ride out on horseback armed with our bow and arrows with our hunting dogs running alongside. It was so exciting! I once shot a deer straight through the heart, what luck! After the hunt all the animals we'd caught were given to the kitchen to be cooked for a big feast in the evening. Mmmmm.





Everyone dressed in their finest clothes for the feast. The maids hated feasts because I'd always spill meat juice down my shirt that they had to clean. Whoops. After all the food there'd be dancing. I hated dancing, it was so boring. I'd sneak out and find the servants' children to play tag with.

My best friend was Tommy; his dad was the groom at Tixall. We always went riding together across the parklands. He was so good with horses, even the wildest ones let him ride them. Sometimes I wish I was a groom like Tommy so I could spend all day with horses instead of having to learn how to write and do maths and speak Latin. Draw a picture of us riding in the box below.

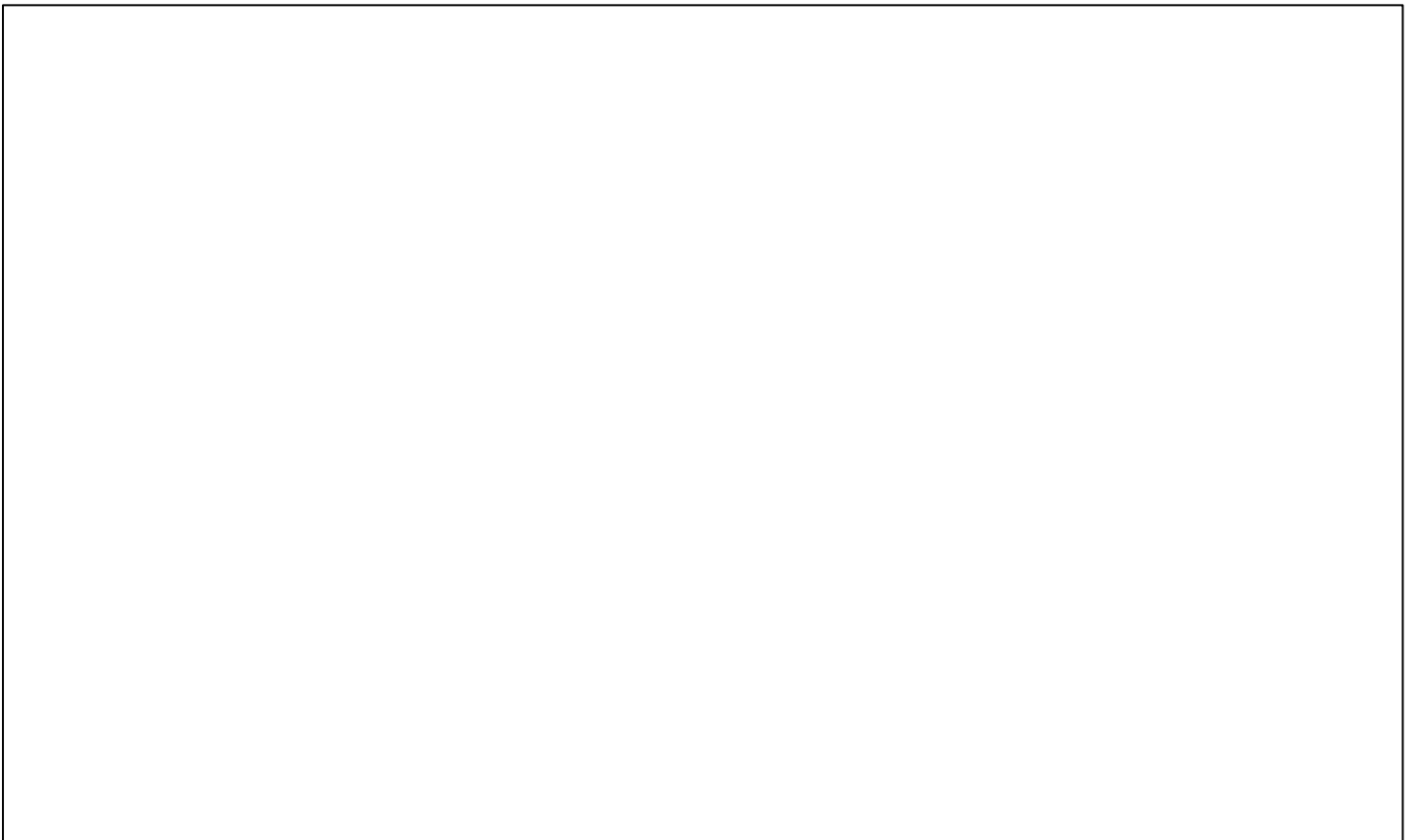

One day dad told us that we were to look after a very important prisoner at Tixall. Imagine that! The Catholic queen, Mary Queen of Scots was imprisoned here for two weeks. Dad banned all of us from talking to her in case she tried to make us Catholics too. Not a good idea as Parliament had made being a Catholic against the law. Only the servants were allowed into her locked room to give her food. Tommy told me that his friends in the kitchen said that she was very kind and cried all day in her room. Poor Mary not long after she was with us Elizabeth I decided to have her head cut off – though she was plotting to steal Elizabeth's throne and be Queen of England instead.

Unruly Rulers

Who were the Tudor and Stuart kings and queens?

This lot were a blood thirsty bunch, always chopping off heads. **Tudor** and **Stuart** are the family names of the kings and queens. The first Tudor was Henry VII in 1485 and they lasted till Elizabeth I. Then the Tudors' cousins, the Stuarts, ruled from James I to Anne.



King Edward VI

Henry VIII's only son, he had some big shoes (and clothes) to fill! King at nine and dead at 16. Poor Eddie.



Queen Mary I

Back to Catholics again. Bloody Mary was her name, burning Protestants was her game.



King James I

What a silly king, he kept thinking witches were trying to kill him! He even wrote a book on witches.



Oliver Cromwell

Not a king but still a ruler. He didn't like the royals and made himself Lord Protector of England. He didn't last too long.



King James II

A bit dim was this king. He tried to make everyone Catholic again, then ran away when they said no.



Queen Anne

A sickly queen who loved to eat!

1509

King Henry VIII

6 wives, only 1 son. Angry at the Pope horrible Henry made himself Head of the Church destroying all the Catholics churches.



1547

Lady Jane Grey

Only 16 when she became Queen for just 9 days before Mary Tudor took the throne. Off with her head!



1553

Queen Elizabeth I

Good Queen Bess knew leaving religion alone was best. (Unless the Catholics attacked!) Had lots of boyfriends but married none.

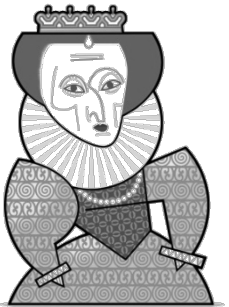

1158

1603

King Charles I

Bad King Charlie wanted to rule without Parliament. That started a civil war which he lost. Onto the block went Charlie's head. One chop and he was dead.



1625

1649

King Charles II

A merry monarch who brought back fun and games Oliver had banned!



1685

Queen Mary II & William III

She and her husband took her dad, James II's throne in the Glorious Revolution. Not so glorious for James.



1688

1702-1714



Meet Queen Elizabeth I

– who ruled when Eddie lived here.

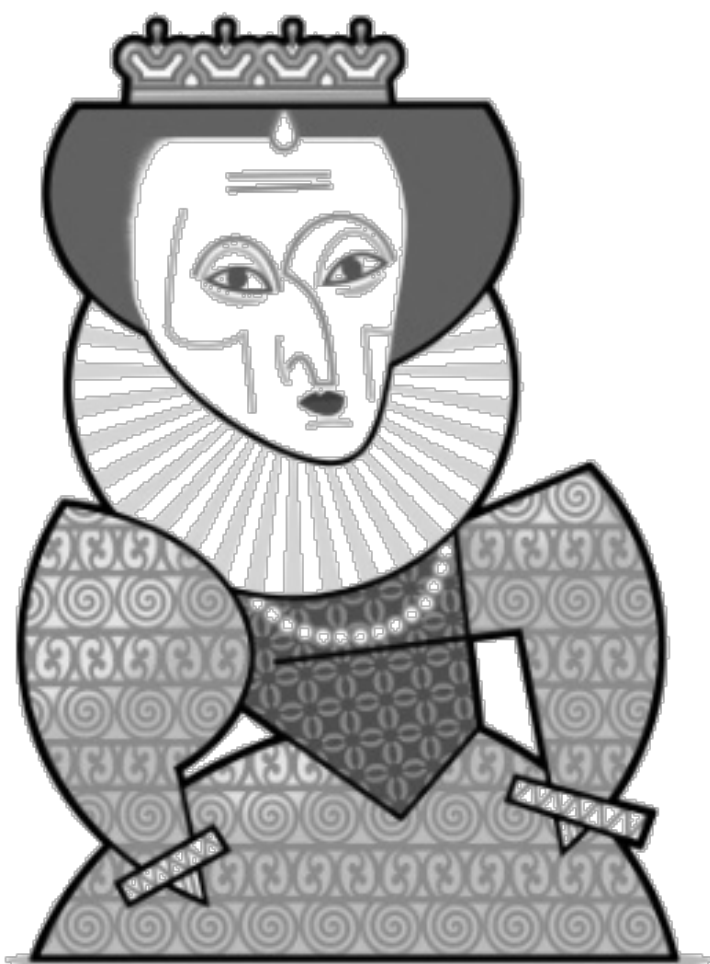

Hi Lizzie!

So when did you become queen?

I became Queen on 17 September 1533 when I was 25.

What are you most famous for?

I defeated the Spanish army who tried to invade England. How dare they?

What is your favourite thing to do?

I loved having a bath and being clean, I have 4 baths every year! I was the cleanest woman in England. And I LOVE sweets.

What is the naughtiest thing you've ever done?

I pretended to be a Catholic when my half-sister bloody Mary was queen; once she was dead I turned England Protestant again!



What does Tixall Gatehouse look like?

Can you walk all the way around it?

Can you use any of these words to describe the building? Draw a circle around the ones that do.

Does Tixall Gatehouse look like other buildings in the area? What's different about it?

Castle

Pretty

Stone

Symmetrical

Square

Friendly

Tall

Industrial

Brick

Home

Elegant

Low

Tixall Gatehouse was built in 1580 by Sir Walter Aston. It was built in front of his home Tixall Hall which had been there since 1555.

Old Tixall Hall wasn't as fancy as the new gatehouse. Sir Walter wanted to show that he was keeping up with the new, fashionable style of building so he built the gatehouse in a **classical** style of architecture (say 'arch-i-tec-ture'). Lots of rich people went travelling to Italy and saw old Greek and Roman buildings that they liked. There were books of drawings of old buildings to copy too, so people began to use the same style in their own new buildings. Old Tixall Hall fell into ruins and was knocked down in 1927, but the gatehouse survived.

Fact:

Classical architecture isn't something to do with music! It means that the building was inspired by old Roman and Greek buildings.





Buildings are quite easy to draw. They are usually made up of lots of geometric shapes, like squares, triangles and circles.

Have a go at drawing the front of Tixall Gatehouse.

Please tell an adult where you are going so they don't worry about where you are!
And don't worry if you make a mess of your drawing, just use the other side.

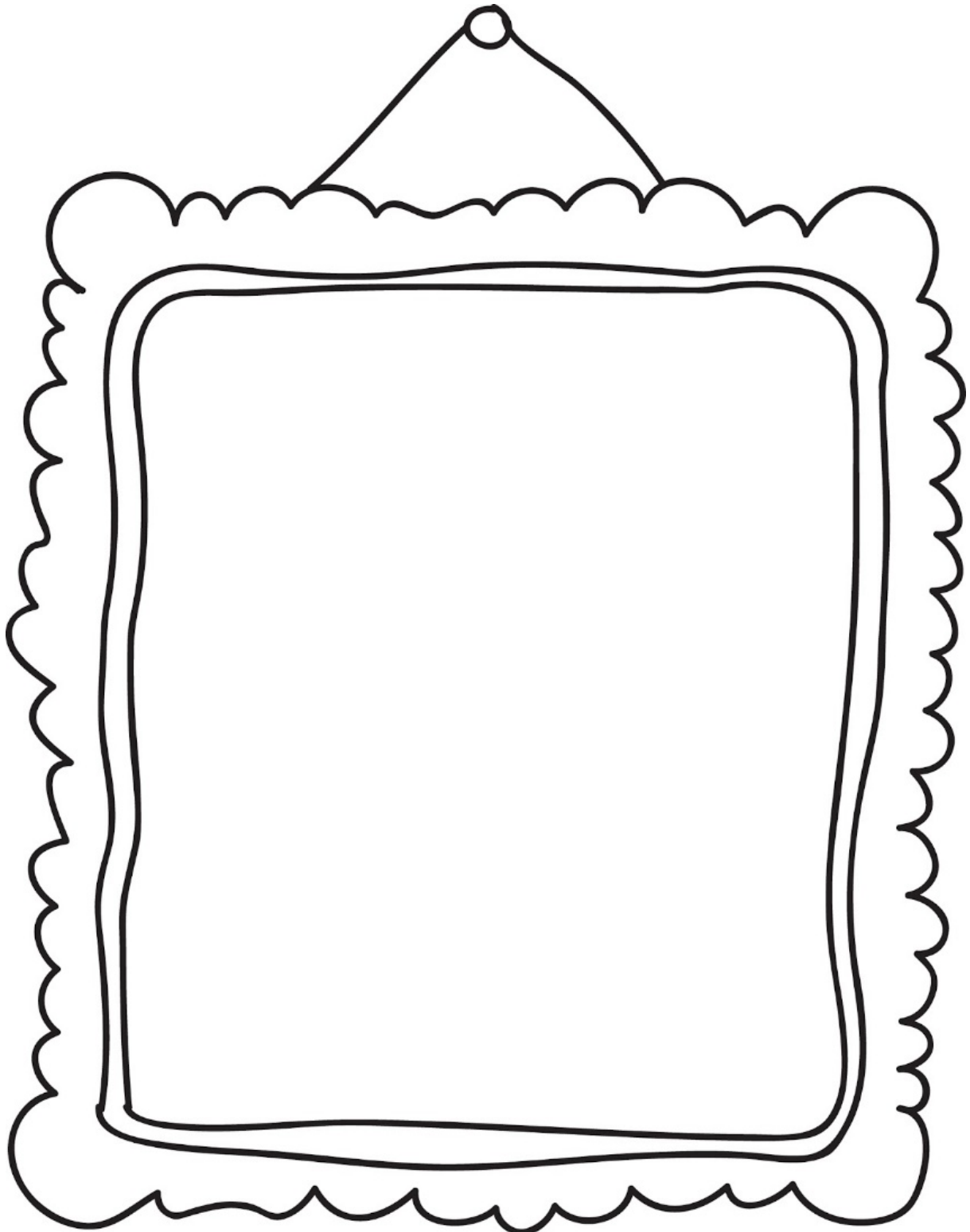



Different types of columns.

One easy way to tell if a building is in the Classical style is by looking for columns. Columns are a way of supporting the weight of a building. They come in all different shapes and sizes. There are 3 different parts to a column:

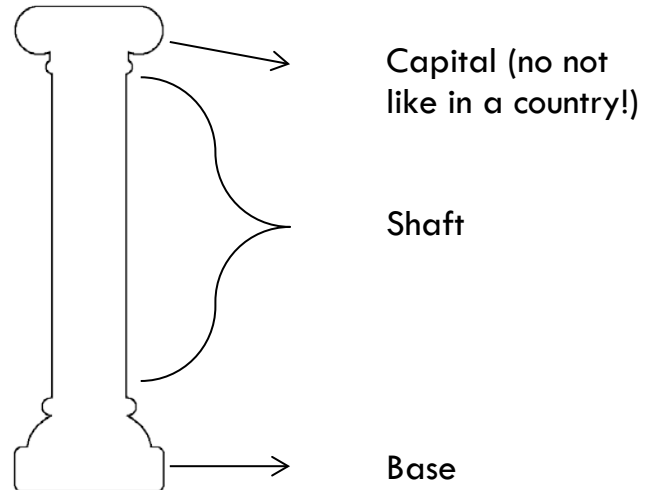

The ancient Greeks used 3 different types of capital in their buildings:

Doric

This is the oldest and simplest.

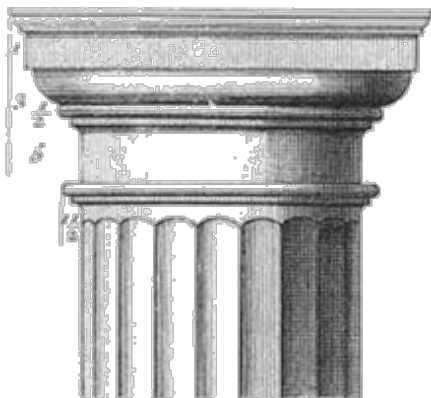

Ionic

This looks like a scroll.

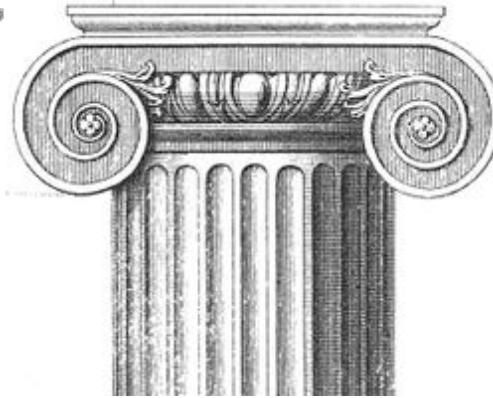

Corinthian

Based on the leaves of a plant called 'acanthus' (say 'a-can-th-us')



Then the Romans adapted them to have two more sorts of capitals:

Tuscan

Is like the Doric column but simpler.

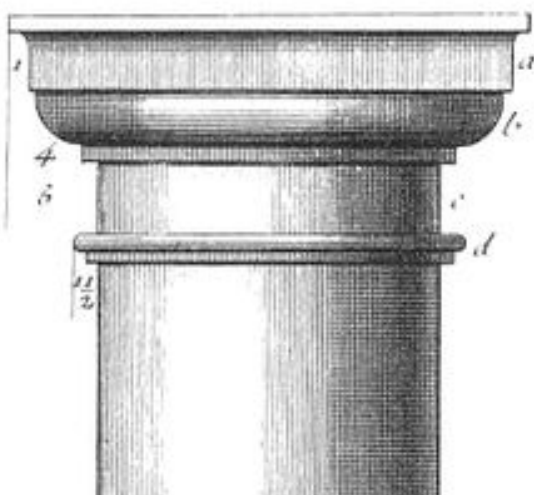

Composite

Is a mixture of Ionic and Corinthian.





Have a go at designing your own capital:

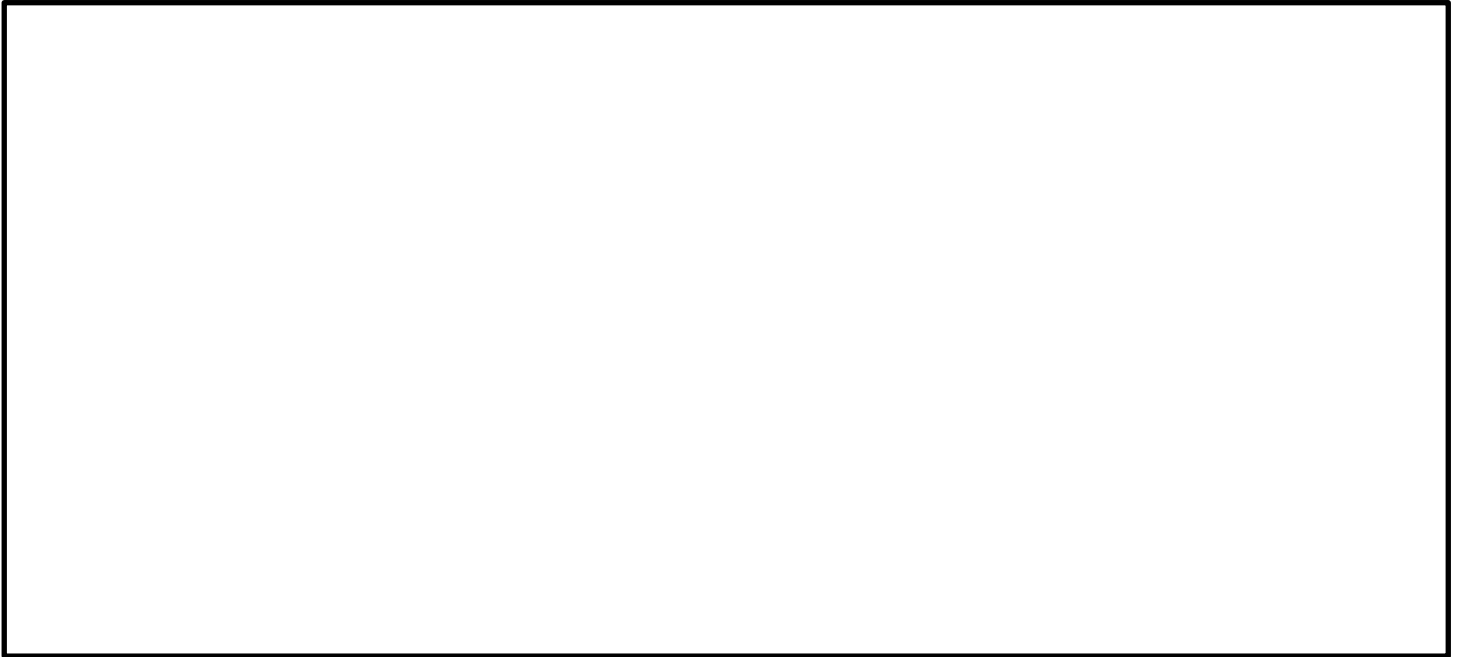

Sometimes stone masons carved faces and animals called gargoyles. You often find these in churches, up near the roof. There are lots here at Tixall, how many can you see?
Here are some examples. Have a go at designing your own gargoyle in the box below. Make it as ugly as you like!

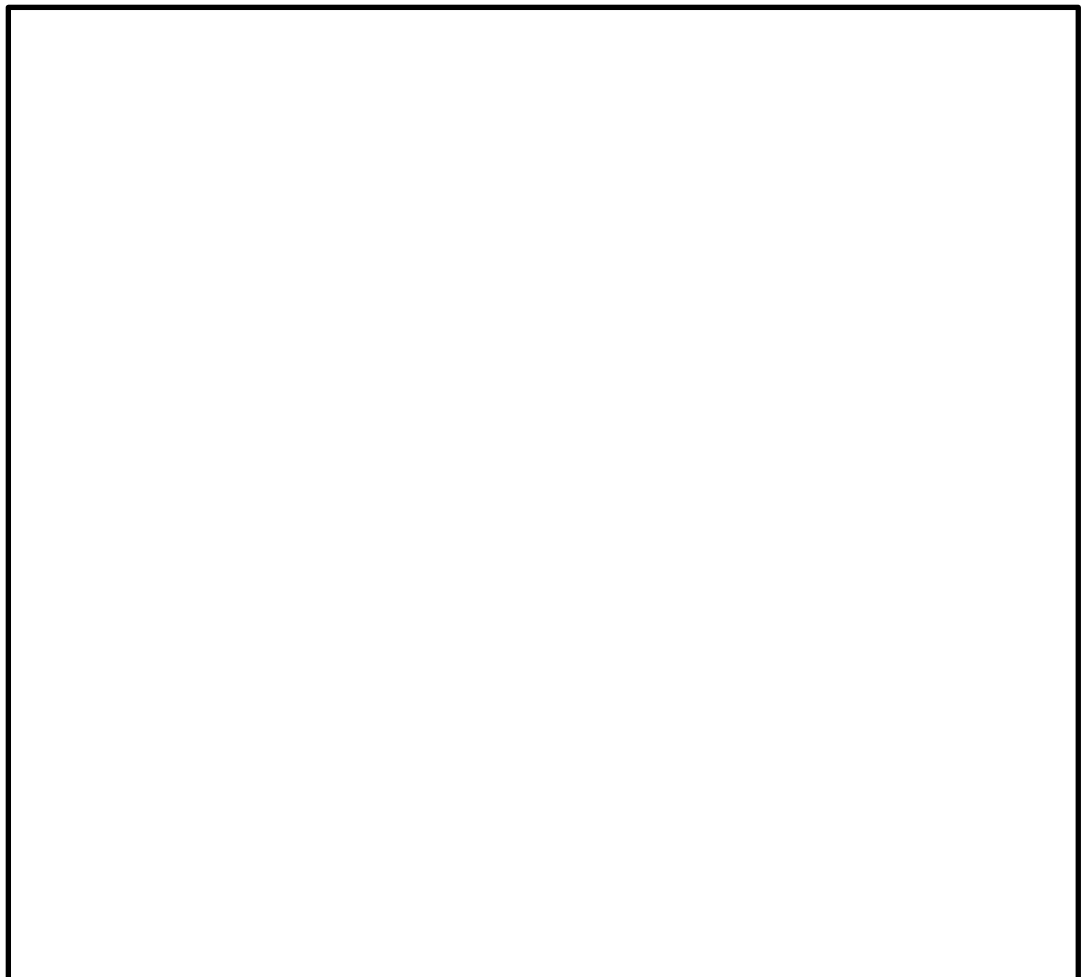



What is Tixall Gatehouse built from?

Fact:

Some buildings were built from stone that was dug out of the ground when farmers ploughed the fields, other buildings were made from stone that was quarried and cut into neat shapes and sizes. There are still many stone quarries around the country today, where people get stone out of the ground.

Stone houses were once cheaper to build than brick ones. Once we could transport bricks up and down the country on the canals and railways, brick buildings become cheaper and more popular.

Stone is the solid foundation of the earth. It exists as huge mountains, rocks, stones or small pebbles washed smooth by water. There are lots of different types of stone, with different colours and textures. Some are better to build with than others.



When Tixall Gatehouse was built, stone was still taken out of the ground by hand. Tixall gatehouse is built from Tixall stone that was dug from the ground very close by. Today, a quarry is a place where stone is blasted out of the ground with explosives! The one in the picture shows what quarries look like now.



People who work with stone are called stonemasons. They build walls, carve the stone into shapes or add patterns to its surface. They use a mallet and special tools called chisels to shape the stone. The picture on the right shows a stonemason carving the stone.

Mallet

Chisels





The size and shape of windows tells you a lot about the age and style of the building. What type of windows does Tixall Gatehouse have?

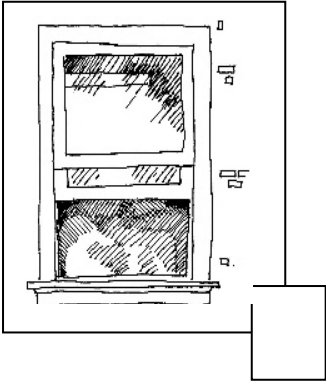

Sash

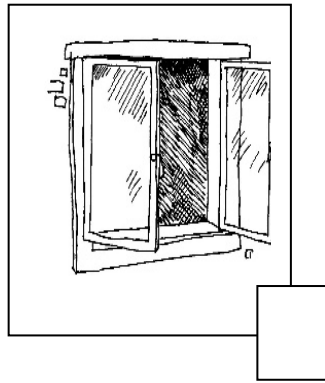

Casement (it opens)

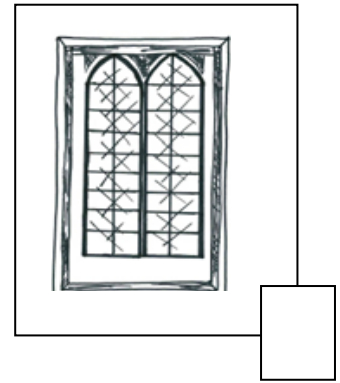

Pointed or Gothic

There are many different styles of staircases. Which style is closest to the staircase at Tixall Gatehouse?

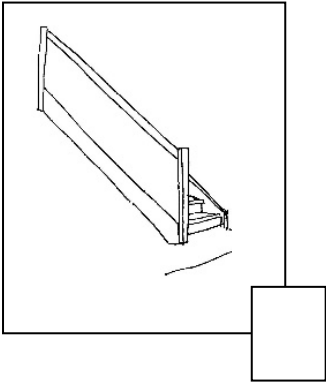

Straight

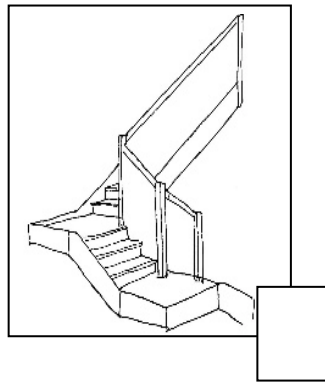

Quarter turn

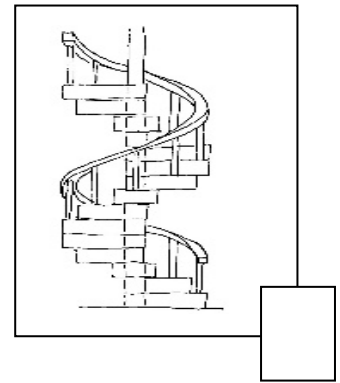

Spiral

Fact:

Have you noticed that spiral staircases go clockwise when you're going up and anti-clockwise when you're going down? This is because most people are right handed so if there was an attacker with a sword coming up the stairs they had to show more of their body to fight. The swords man above had the wall on his left leaving more room to fight with his right arm.

Entrances can be grand or simple. Which front door is most like the one at Tixall Gatehouse?

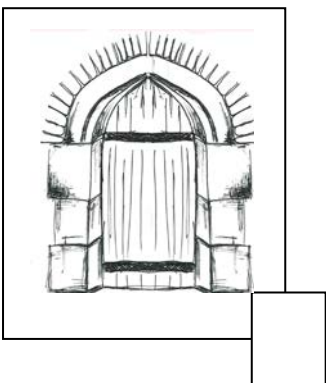

Tudor arch

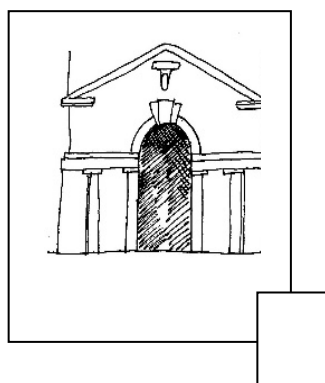

Porch

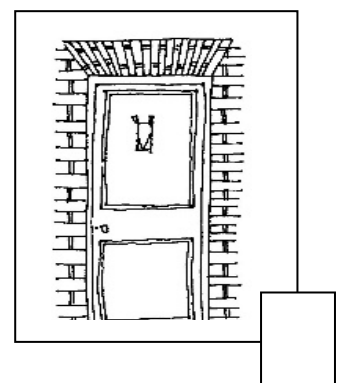

Doorframe

Quest



Discover more about Tixall Gatehouse

Tixall Gatehouse was built around 1580. That's over 400 years ago! In that time, many things have changed both inside and outside the building. Follow this Quest to discover more about it.

Can you find the angel and knight?

Imagine how hard it was to carve them out of stone! The knights are on the outside of the gate, the angels faced the courtyard of the Old Hall. Why do you think they are that way round?



.....

.....

.....



Can you find the weather vanes?

Do you see they shine in the sun? They are coated in gold leaf. Each one has a different number which together makes 1976, the year that Landmark put the weather vanes on the turrets.

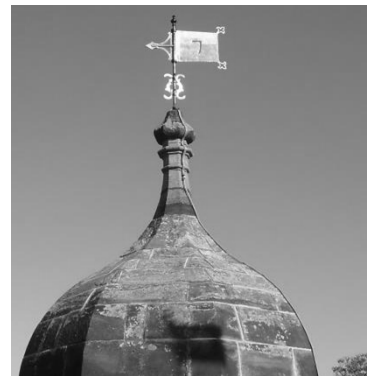

**Have you found anything else interesting on your quest?
Write about it below and draw a picture of it in the box.**



Living in Tixall Gatehouse

The floorplan of a building is a map of the rooms. Tixall Gatehouse has three floors. The plans below show you the top two floors and the shape of each room. Take a walk around and write on the plan what each room is used for.

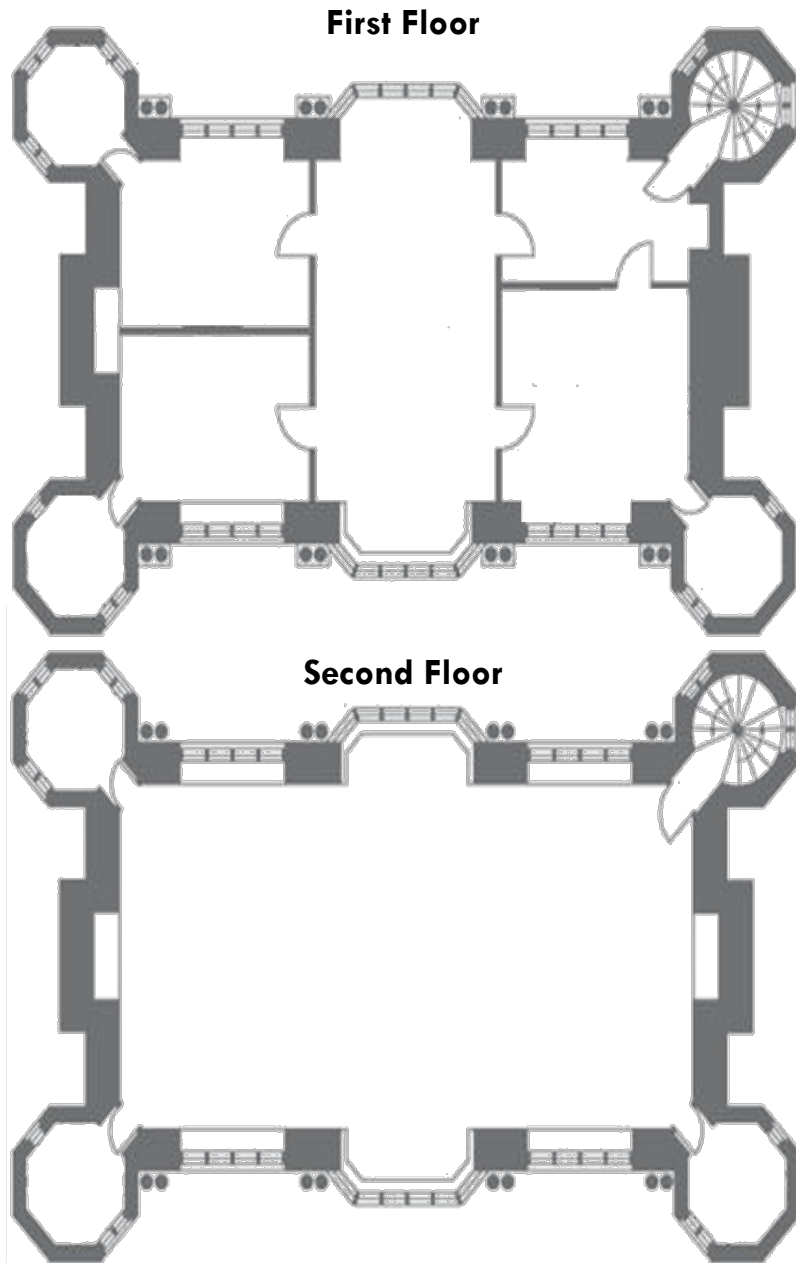

We use these symbols to show where beds, tables and bathrooms are. Draw the symbols on to the floorplans to show where the furniture is.

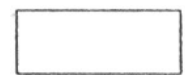
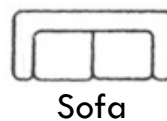
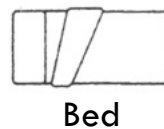



Can you find an example of each of these things inside Tixall Gatehouse. Describe, or draw the object when you find it.

Your favourite chair

A large empty rectangular box intended for drawing or describing a favourite chair.

The fireplace (is it an open fire or does it have a stove?)

A large empty rectangular box intended for drawing or describing a fireplace.

Draw the pattern of a rug on the floor

A large empty rectangular box intended for drawing the pattern of a rug.

In the box below, draw the view from your bedroom window. What can you see in the distance? Are there any animals in the fields or any trees that look very old and interesting?

A very large empty rectangular box intended for drawing a view from a bedroom window.



Sir Walter Aston's Word Search

Now have a go at the word search. Think about different parts of the building and what might have been here when Sir Walter Aston lived here. The words to find are at the bottom of the page.

E	P	R	O	T	E	S	T	A	N	T	I	T
C	L	A	P	A	R	K	L	A	N	D	R	L
O	T	I	N	I	T	H	G	I	N	K	L	O
U	O	H	Z	E	R	U	U	Q	D	A	T	W
N	N	Y	N	A	A	A	R	S	X	O	W	X
T	R	A	F	H	B	S	L	I	U	H	N	E
R	E	S	U	O	H	E	T	A	G	O	F	Y
Y	E	H	N	R	T	Y	T	H	A	S	F	E
S	D	C	O	S	R	A	U	H	G	E	I	N
I	R	A	R	E	I	L	R	L	A	T	R	M
D	O	L	I	S	A	B	R	X	N	N	E	I
E	D	S	T	O	N	E	E	C	O	W	H	H
H	U	N	T	I	N	G	T	R	E	E	S	C
S	T	A	F	F	O	R	D	S	H	I	R	E

ELIZABETHAN
TURRET
STAFFORDSHIRE
TUDOR
STONE

GATEHOUSE
TIXALL
TREES
DEER
SHERIFF

SPIRAL
FARM
COUNTRYSIDE
HUNTING
HORSES

CHIMNEY
COW
PROTESTANT
PARKLAND
KNIGHT

How many of these words did you find? Put your score in the box.

20



Can you answer these questions correctly?

1. What was Queen Elizabeth I's nickname?

Good Queen Bess

Lilibet

Queenie

Liz

2. What was a Tudor toilet called?

Loo

Jake

Redorter

Lavatory

3. What year did the first Tudor become king?

1507

1485

1600

1321

4. Which of these animals might have the Elizabethans have killed on a hunt?

Dolphins

Deer

Leopards

Polar bears

5. How many wives did Henry VIII have?

1

2

6

8

6. Which of these activities was NOT around in Tudor times?

Tennis

Jousting

BMX-ing

Cards

7. Which of these two would NOT be found at a Tudor dinner table?

Chopsticks

Knife

Fork

Spoon

8. Which of these names has a King of England NOT had?

Henry

Charles

George

Max

9. Who came after the Tudors?

Georgians

Windsors

Stuarts

Hanoverians

10. Which Queen was kept as a prisoner at Tixall Gatehouse?

Mary Queen of Scots

Queen Matilda

Queen Elizabeth

Queen Victoria

To find the answers skip a page...



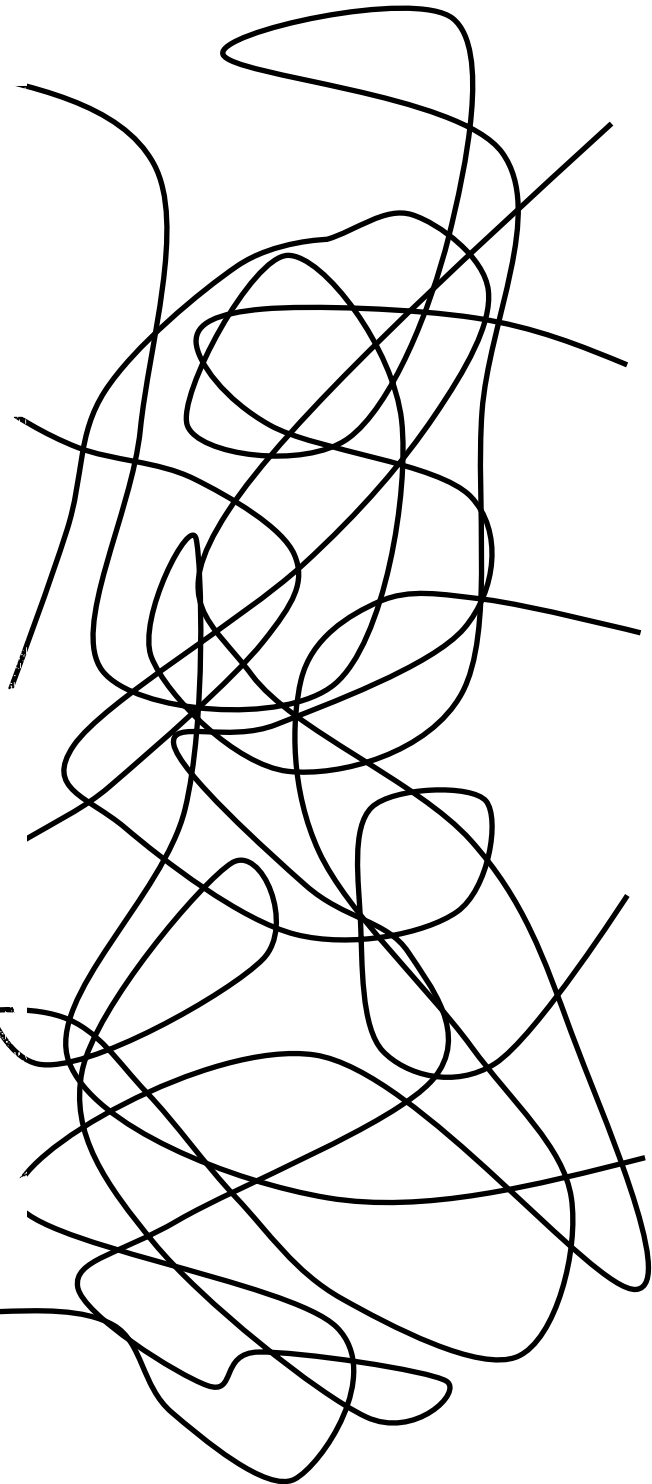

Which leaf belongs to which tree?

Match the leaf to the correct tree.

1.  

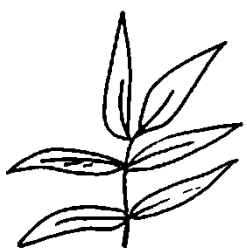
Horse Chestnut

2.  Willow

3.  Pine

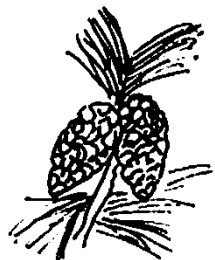
4.  Ash

5.  Oak

Did you match them correctly? Put your score in the box.

Look out for these when you go for a walk!



Answer sheet:

Question & Answer:

1. Good Queen Bess
2. Jake
3. 1485
4. Deer
5. 6
6. BMX-ing
7. Chopsticks and Forks
8. Max
9. Stuarts
10. Mary Queen of Scots

How many did you get right?

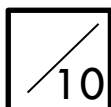

Fact:

The Tudor name for a toilet is **Jake**. Weird huh! A Jake wasn't like our toilets – there was no system to wash away the poo. It just fell down into a pit! Ewww. The pits had to be opened up and the poo was shovelled and carted away. What a smelly job. Thank goodness for flushing toilets hey!



Imagine you lived here 550 years ago. Which year would that be? 15__ __. Write an acrostic poem describing life at Tixall. Each line has to begin with the letter shown, so that the lines spell 'Tixall'! We've written the first line for you...

Tixall is my home, Elizabeth is my queen.

I

X

A

L

L

Design your own gatehouse

Imagine you've just bought a big country house. You want to protect it and make it look even grander so you build a gatehouse. In the box below design your very own gatehouse – it can be as big and fancy as you like!



Make some apple fritters

Fritters are an old type of doughnut. They have been popular since Roman times. In the medieval times they thought that it was dangerous to eat more than one fritter - how silly! Everyone forgot about this in Tudor and Stuart times and they were popular again. Phew!

Here's a simple recipe for you to try. You might need the help of an adult.

1 cup double cream
2 whole eggs
2 egg whites
1/3 cup apple juice
6 apples
Sunflower oil

1 tablespoon flour
1 teaspoon rosewater
2 tablespoons sugar
1/4 teaspoon nutmeg
1/4 teaspoon salt
4 sponge fingers

- Mix the cream, egg whites and eggs
- In a different bowl crumble the sponge fingers
- Mix the spongefingers with the apple juice, rosewater, flour, sugar, nutmeg and salt until soft
- Mix the two bowls of ingredients together. Add the cream and eggs to the sponge fingers and mix very well.
- Peel and core the apples, then slice them into wedges
- In a big pan heat the oil – just enough for the fritters to sizzle in. Careful, it might spit a bit!
- Dip apples in the batter and then cook in the oil for 1 minute on each side until brown
- Serve with some vanilla ice cream. Mmmmmm!





Colour in these Tudor outfits.

