



## Find out about Plas Uchaf's past . . .

Hello and welcome! My name is Neste and I was born in 1400 at **Plas Uchaf** (say *Plass-Oo-caff*). That's over 500 years ago! Our house was new then and all my family thought it was very special and modern.

I'm ten now, I have an older brother called Euron and he's thirteen. My father is a **baron's steward**, he's called Cradoc and my mother is called Bab. We are pretty well off compared with most people so we have servants!

### Fact:

**A baron's steward** – is the man who managed the lands of the **baron**, a nobleman who owns land farmed by the peasants. The peasants farm the land and swear loyalty to their 'lord' in the manor house. They get protection and justice in return. In medieval times, there were about 300 Barons, who got their lands from the King.

**Plas** and **uchaf** are both Welsh words. In English **plas** means large house or mansion and **uchaf** means upper or high, so **Plas Uchaf** means the **Large House which is high up**.

Euron and I work hard at home and outside it too. We have to do everything we're told because we're children. Though it's quiet round here in your time, in my time our house is always full of people coming and going. As our father is a **baron's steward**, he's an important person around here and he tells other people what they can and can't do!

There are lots of other nearby small cottages (hovels really) lived in by peasants who have to do what our dad says. The peasants plough the land around and grow cereal crops such as oats, rye, peas and barley. They give our father some of their crops in return for him letting them farm the land. They also have to give him "service" – help with his harvest, mending roads and things like that.



When Euron grows up and our father dies, he will become the baron's next steward. We all agree that he's not really suited to it. He doesn't like telling people what to do and would rather be off on his own, playing music and making up poems. He loves the musicians and bards who come and make music and tell stories and poems in our great hall.



Sometimes, we have to go with our father to collect fines from the peasants when they do something wrong – or if they just don't do something they're supposed to. That feels a bit awkward to me and Cradoc looks as though he wishes he weren't there. One time, Anerin- he's a peasant friend of Cradoc- was caught taking extra firewood so he was punished. What's the naughtiest thing you've ever done?

---

In the Middle Ages, we have some punishments you'll think are a bit mean. Thieves were put in the stocks where everyone could see they had been naughty! We had great fun throwing rotten veg at them or even tickling their feet. Hee hee!!

In our house in winter we stay warm by having a big fire in the middle of the floor (yes, really- right on the floor) and the smoke goes up through a hole in the roof.

Although it can get very smoky in the great hall, I love the feeling of being safe and snug inside our beautiful hall.

I like it best when a travelling minstrel or bard stays with us. They play instruments, sing songs and tell stories in return for a place to sleep and some food. Anerin likes to get them to sing songs which are a bit rude!

We grow and make everything we need so it's a bit like being in our own small world here. We get all our news here from the minstrels.

It was big news when the carpenter's son wanted to become a monk and move away. He had to ask our father's permission and pay the baron a fine for leaving the farm!



Plas Uchaf stayed a farm for centuries. Later, a tailor and a gamekeeper lived and worked here. The last farming family to live here were, the Owens, and they left here in the 1960s. After that, the house lay empty and derelict for over 10 years and was in need of help! In 1971, the Landmark Trust restored it and since then many families have enjoyed staying here in this beautiful countryside. I hope you will too!

# Unruly Rulers

## Who were the medieval (say 'med-ee-evil') kings?

**Medieval** means in the Middle Ages. This is roughly from when William the Conqueror and the Normans invaded England in 1066 until Henry VIII (that's the 8<sup>th</sup>) became king in 1509.



### King William II Rufus

He was killed hunting.  
People say that Henry I ordered it!

1066

### William the Conqueror

He wasn't even English he came from France.



1087

### King Henry I

He stole the throne from his older brother who was away on Crusade.



1100

### King Stephen

Another king who stole the throne, it was meant to be his cousin Matilda's!



1135

### King Henry II

Some of his knights heard that he was angry at Thomas Becket, the Archbishop of Canterbury. That was the end of poor Thomas, the knights killed him.



1154

### King Richard I The Lion Heart

A brave king, he was always fighting a war.



1189

### King John

Bad King John, he was a cruel and horrible man. He died eating too many peaches!



1199

### King Henry III

He was a good king who gave money to the poor and liked to pray.



1216

### King Edward I

He invaded and conquered both Wales and Scotland ruling both of them!



1272

### King Edward II

Another bad King, he only listened to his best friend Piers Gaveston and died a nasty death in a dungeon



1307

### King Edward III

He was a good king, even if he did start the 100 years' war.



1327

### King Richard II

He tried to rule without parliament, so the barons helped the next Henry become king.



1377

### King Henry IV

He stole the throne from Richard when he was fighting in Ireland. Hard luck Richie!



1399

### King Henry V

He wanted to be King of England and France. You guessed it, he started a war!



1413



1422 **King Henry VI**

He became king at 8 months old! He was weak and hated war. He never fought in any battles.



**King Edward IV**

He secretly married Elizabeth Woodville. Some say she was a witch!



1461

**King Edward V**

He was 10 when he became king for 86 days. Then uncle Richard put him and his brother in a tower.



1483

**King Richard III**

He was a bad king. People say he had his nephews murdered in the Tower of London so he could be king instead.



1483

**King Henry VII**

He defeated bad King Richard and became the first Tudor king. Hooray!



1485

**Meet King Henry IV**  
– who ruled when Neste lived at Plas Uchaf.

**Hi Henry!**

**So when did you become king?**

I became King on 30 September 1399 when I was 32.

**What's your nickname?**

Some people call me 'Henry Bolingbroke' because I was born at Bolingbroke Castle in Lincolnshire in England.

**What are you most famous for?**

I stole the throne from King Richard when he was away fighting in Ireland!





## What does Plas Uchaf look like?

Can you walk all the way around it?

Can you use any of these words to describe the building? Draw a circle around the ones that do.

Does Plas Uchaf look like other buildings in the area? What's different about it?

Castle

Pretty

Stone

Symmetrical

Square

Friendly

Tall

Industrial

Brick

Home

Elegant

Low

Plas Uchaf has been in place for over six centuries, it was built in about 1400, or perhaps before. That's over 600 years ago!

About two hundred years after Plas Uchaf was built around 1600, a first floor was put in the hall. That's the enormous main room. But then those ancient beams and panelling were removed and sold to an American in the 1960s. Imagine them going all that way, to be made into a new house in America!

### How can we tell how old the beams are in a building?

We can tell which year the trees that made the beams were cut down using a scientific process called **dendrochronology** (say *dend-row-cron-ologee*). You can read more about this on the next page.

What's your favourite room in the house? Draw it here.



## What is Plas Uchaf built from?

### Fact:

The simplest house frame was a Cruck. A curved tree was cut in two pieces along its length. You needed one cruck at each end of the building and one in the middle. This created your frame, which you then added to and filled in with mud walls and a straw thatched roof.

A Cruck frame was quick to build but it didn't have much room upstairs.

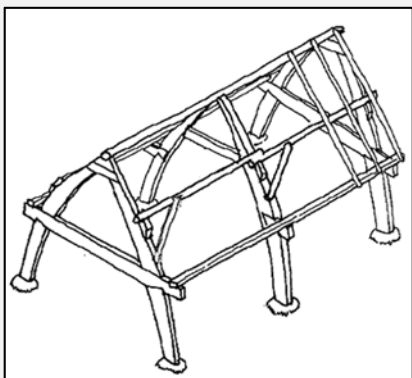

Plas Uchaf is built with a wooden frame. Timber is wood used for building. Today buildings with wooden frames are quite rare. Most were pulled down to make way for more modern buildings. They caught fire easily too. Timber houses were quick and cheap to build. Remember the story of the Three Little Pigs!

The timber from oak trees is the best for building with because it is very hard. Oak is a common tree in Britain, and it was grown especially to supply timber for building – not just houses but ships too. You can still see big oak trees in the countryside today. They look like this, and they have wiggly leaves and acorns in the autumn.



Can you see any oak trees from Plas Uchaf?

People who work with wood are called carpenters. Over time, timber framed houses started to look more like boxes, with a triangle for the roof. People wanted to have proper rooms upstairs.

This is a picture of Langley Gatehouse in Shropshire, also owned by Landmark. The carpenter has made lovely patterns inside the basic box frame as decoration (say 'dec-or-ayshun').





## Dendrochronology: What is it and why is it important?

**Dendrochronology** is the science of dating something by the wood it's made of. Normally you count the growth rings in timber and tree trunks. Each ring is a year in growth: in wet years the tree grows faster than in dry years.

Have you ever counted the rings on a branch or tree stump to see how old the tree was? It's the same technique!

Looking at a cross-section of a tree can teach us a lot about what was happening in the environment around it at certain times.

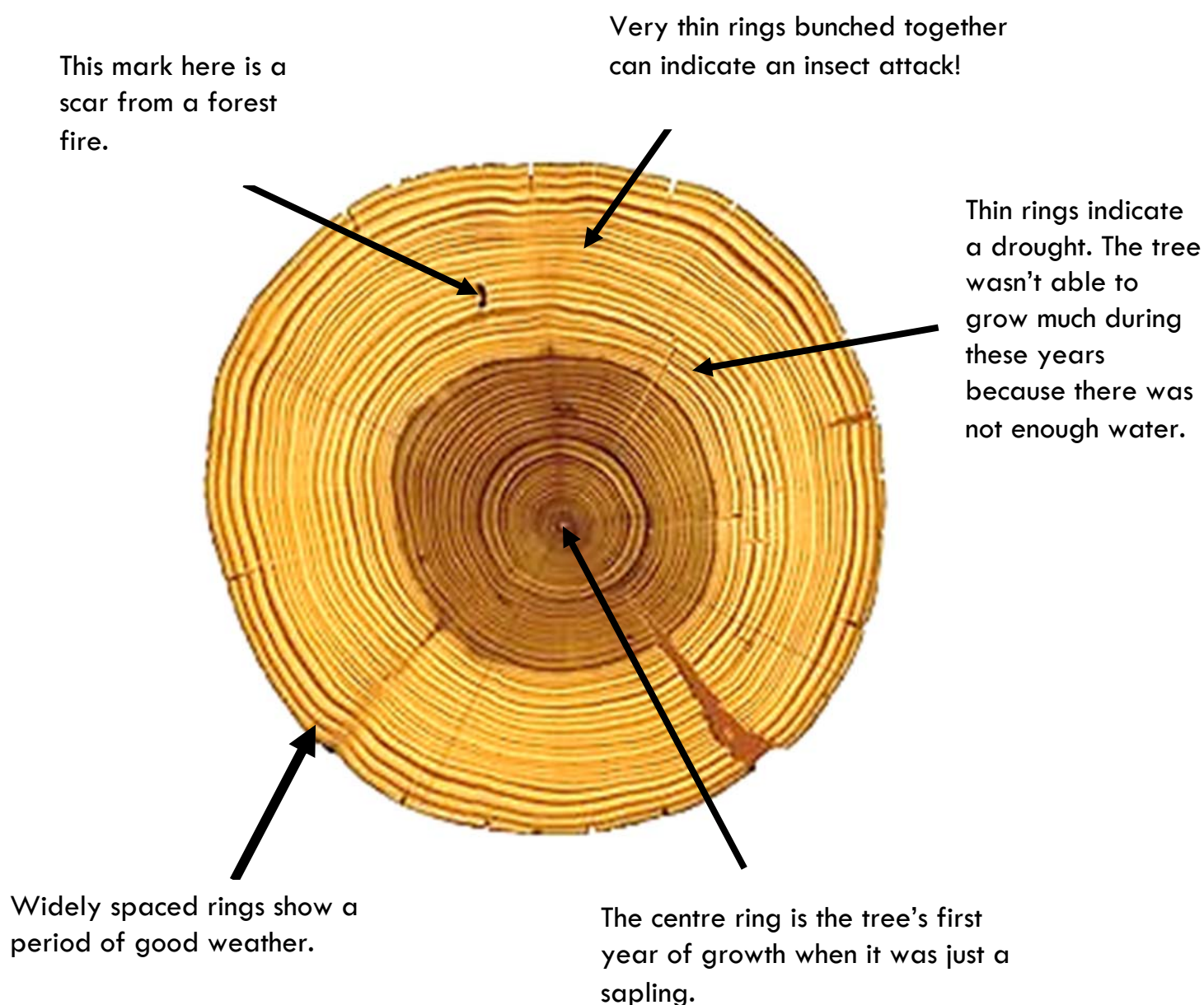

---

Why not go on a walk and find a fallen tree. Try counting its rings and write down below how old it is.

---



Buildings are quite easy to draw. They are usually made up of lots of geometric shapes, like squares, triangles and circles.

**Have a go at drawing Plas Uchaf!**

Please tell an adult where you are going so they don't worry about where you are!

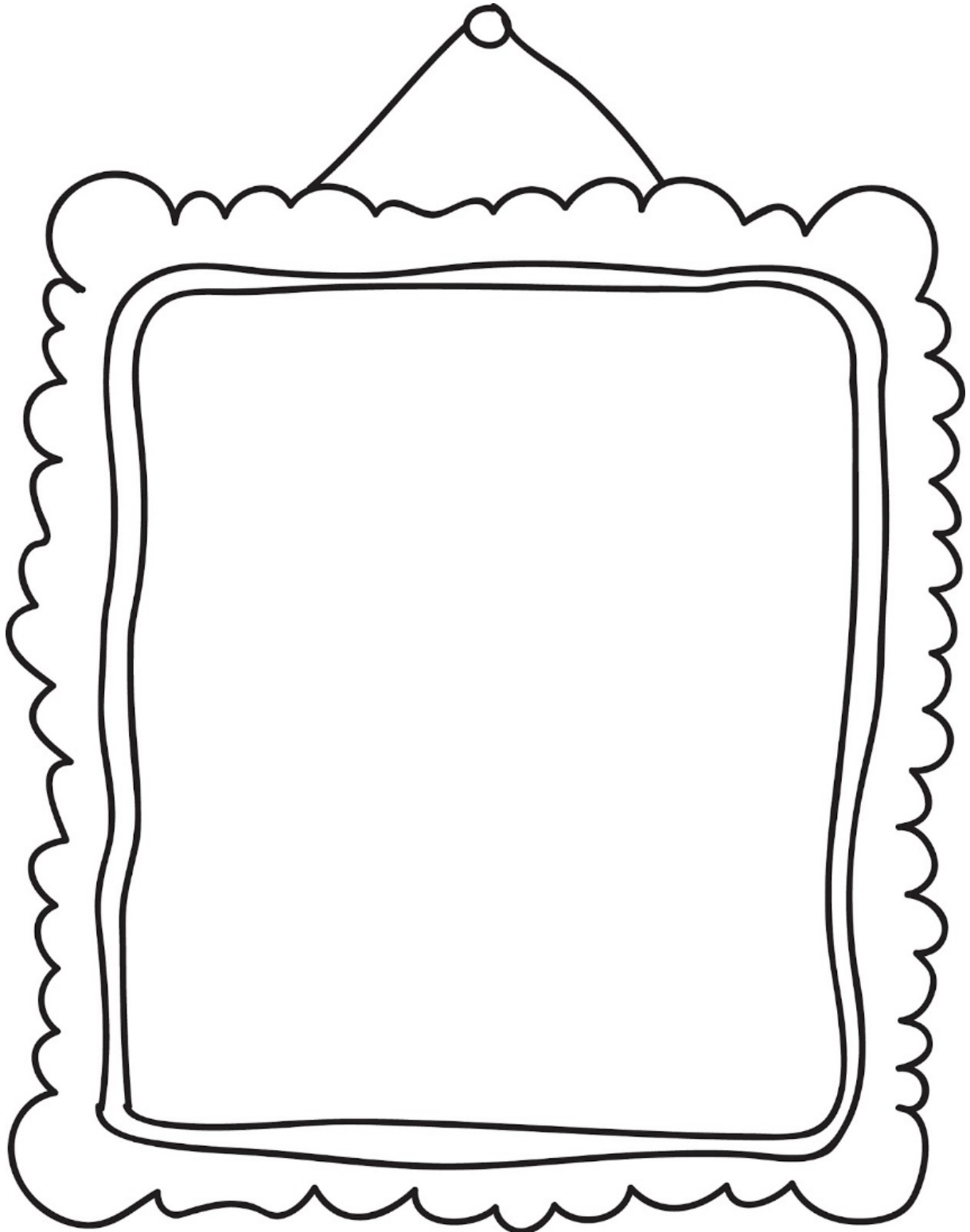





## Can you design your own timber frame?

Imagine the grid below is your timber frame – design a pattern to make it more decorative. The carpenters were clever people and could make curves out of straight pieces of wood – so you can be as creative as you like! You can add windows and doors if you like.

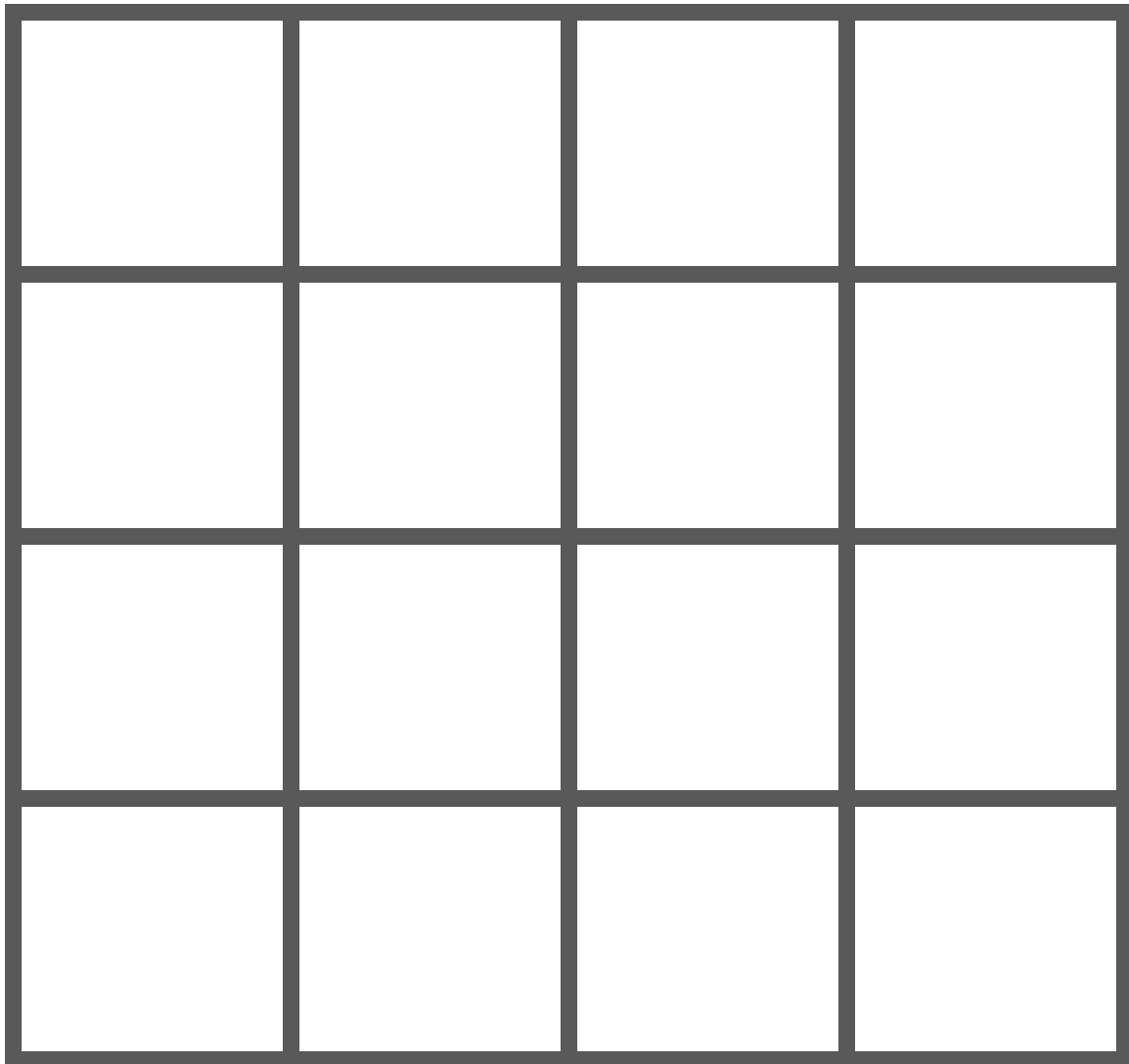

What other building materials can you find outside and inside Plas Uchaf?

Circle what you can see and note down where you found them.

Stone

Wood

Metal

Flint

Glass

Brick

Clay

Concrete

Ceramic

Plastic



# Quest



## Discover more about Plas Uchaf

Plas Uchaf has seen many changes since it was first built. Things have changed both inside and outside the building. Follow this quest to discover more.

### Can you find the place where this photo was taken?

You'll have to go outside. Make sure you tell your adults that you're going outside so they know where you are.

What clue tells you that there are two floors inside at this end of the building?

---



At the other end of the building there's only one floor.

The second photo is of the side of the building closest to the road. Guess how many windows there are in the whole building. Then walk right round the building counting them as you go. Were you about right?

---



### Back inside the building, see if you can find the exact spot where this photo was taken?

Can you spot the internal windows into the twin bedroom?

Did you count those when you were guessing the total number of windows?

Look up at the extraordinary roof, maybe lie on the floor or the sofa- shoes off! What does the roof make you think of?

- 
- 





## Living in Plas Uchaf

The floorplan of a building is a map of the rooms. Plas Uchaf has two floors: The plans below show you the shape of each room. Remember that part of the building is double height which is why the first floor is much smaller than the ground floor. Take a walk around. **Can you identify the rooms and write on the plan how they are used today?**

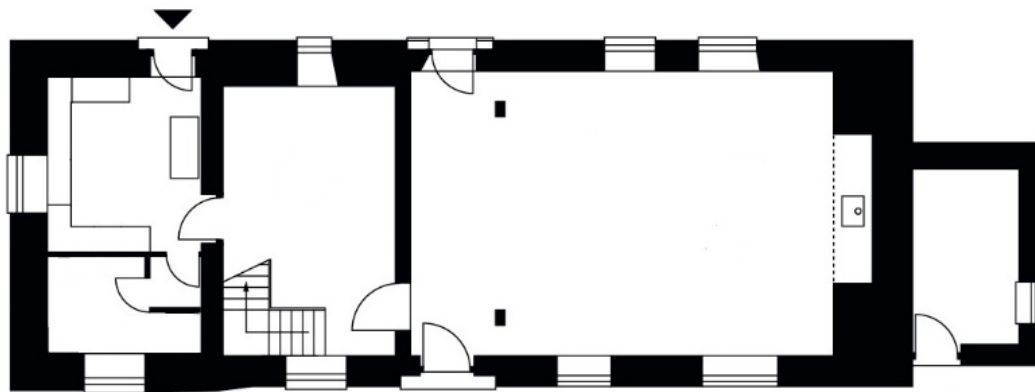

Ground floor

First floor

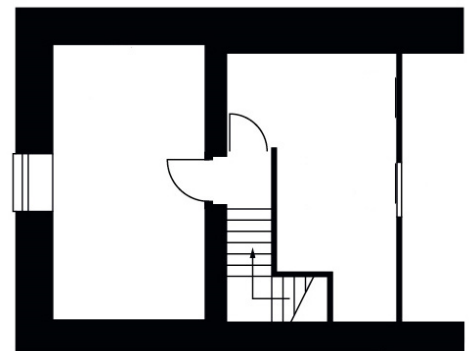

We use these symbols to show where beds, tables and bathrooms are. Add the symbols on to the floorplans to show where the furniture is.

**When you've drawn all the beds, put a star, like this, ★ on the bed you're sleeping in!**

Bed



Rectangular (or a round) table

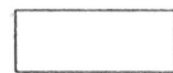

Bathroom



Cooker

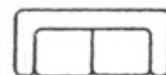

Sofa



Kitchen sink



**Can you find an example of each of these things inside Plas Uchaf? Describe, or draw the object when you find it.**

Your favourite piece of furniture

The fireplace (is it an open fire or does it have a stove?)

The pattern of a rug on the floor

### Fact:

When Plas Uchaf was built it was a very grand timber framed house. The carpenters who made it were extremely skilled and all the woodwork was done to the very highest standards.

In the space below, **draw the view from your bedroom window.** Perhaps you're sleeping in the twin room; then you have an internal view of the hall. What can you see?

A large, empty rectangular box with a black border, intended for drawing the view from a bedroom window.





**Can you answer these questions correctly?** To find the answers skip a page...

**1. When was Plas Uchaf built?**

Fifty five years ago

Over four hundred  
years ago

Over five hundred  
years ago

About one hundred  
and fifty years ago

**2. What is the name for a person, like Neste's Dad, who looked after the baron's lands?**

Steward

Earl

Vicar

Baron

**3. What is dendrochronology?**

A type of cooking

A medieval instrument

The science of dating  
wood

A nobleman's sport

**4. Who was on the throne when Neste lived here?**

(Psst... check Unruly Rulers!)

Henry 1

Richard the Lion Heart

Henry IV

Edward V

**5. How was Plas Uchaf heated when Neste was alive?**

A big fire on the floor

Central heating

Wood burning stove

Cows living below

**6. What's another word for the simple, little cottages that peasants live in?**

Sheds

Skyscrapers

Hovels

Compounds

**7. What crops do the peasants not grow?**

Oil seed rape

Peas

Rye

Barley

**8. Why were people put in the stocks?**

To start a race

To queue for a drink

To check supplies

As a punishment

**9. For how long did Plas Uchaf lie empty and derelict?**

Three years

Over ten years

Five years

A hundred years

**10. When did the Landmark Trust restore Plas Uchaf?**

1917

1791

1990

1971



## Plas Uchaf Word Search

Now have a go at the word search. The words to find are at the bottom of the page. Watch out, they may go forwards, backwards, horizontally, vertically or diagonally!

P	P	T	C	A	T	C	S	K	L	A	W
W	L	E	I	D	O	L	A	E	E	O	A
Q	O	A	E	M	F	O	X	L	O	U	L
M	E	O	S	H	B	D	A	D	L	I	E
E	A	O	D	U	S	E	B	E	A	M	S
D	S	W	N	W	C	O	R	W	E	N	G
I	A	L	R	O	O	H	A	L	L	E	N
E	N	S	A	N	L	R	A	B	T	L	I
V	S	W	O	T	G	T	K	F	U	T	Z
A	E	E	R	R	E	A	R	E	E	D	A
L	E	I	L	E	R	R	I	U	Q	S	M
O	R	V	P	H	E	A	S	A	N	T	A
S	T	O	N	E	I	R	O	M	E	M	P

PLAS UCHAF	MEDIEVAL	FOX	VIEWS
CORWEN	HALL	SHEEP	WOOD
BEAMS	SLATE	PHEASANT	WALKS
TIMBER	STONE	SQUIRREL	AMAZING
WALES	TREES	DEER	WOODWORK

How many of these words did you find? Put your score in the box.





## Answer sheet:

### Quiz answers:

1. Over five hundred years ago
2. Steward
3. The science of dating wood
4. Henry IV
5. A big fire on the floor
6. Hovels
7. Oil seed rape
8. As a punishment
9. Over ten years
10. 1971

How many did you get right?

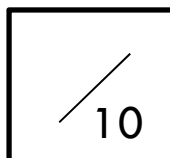

### Pheasant Facts:

Common pheasants are bred to be shot during the shooting season, October 1 to February 1. They were brought to Europe from Asia many centuries ago.

**Over the page there is a picture of a pheasant (say *fez-ant*).**

Why not look up the pheasant in the Bird Book in the Landmark bookcase to copy the colours? The male bird is colourful in order to attract a mate. You might see him surrounded by a group of females who are a dull brown colour.

Have you seen any pheasants during your stay?

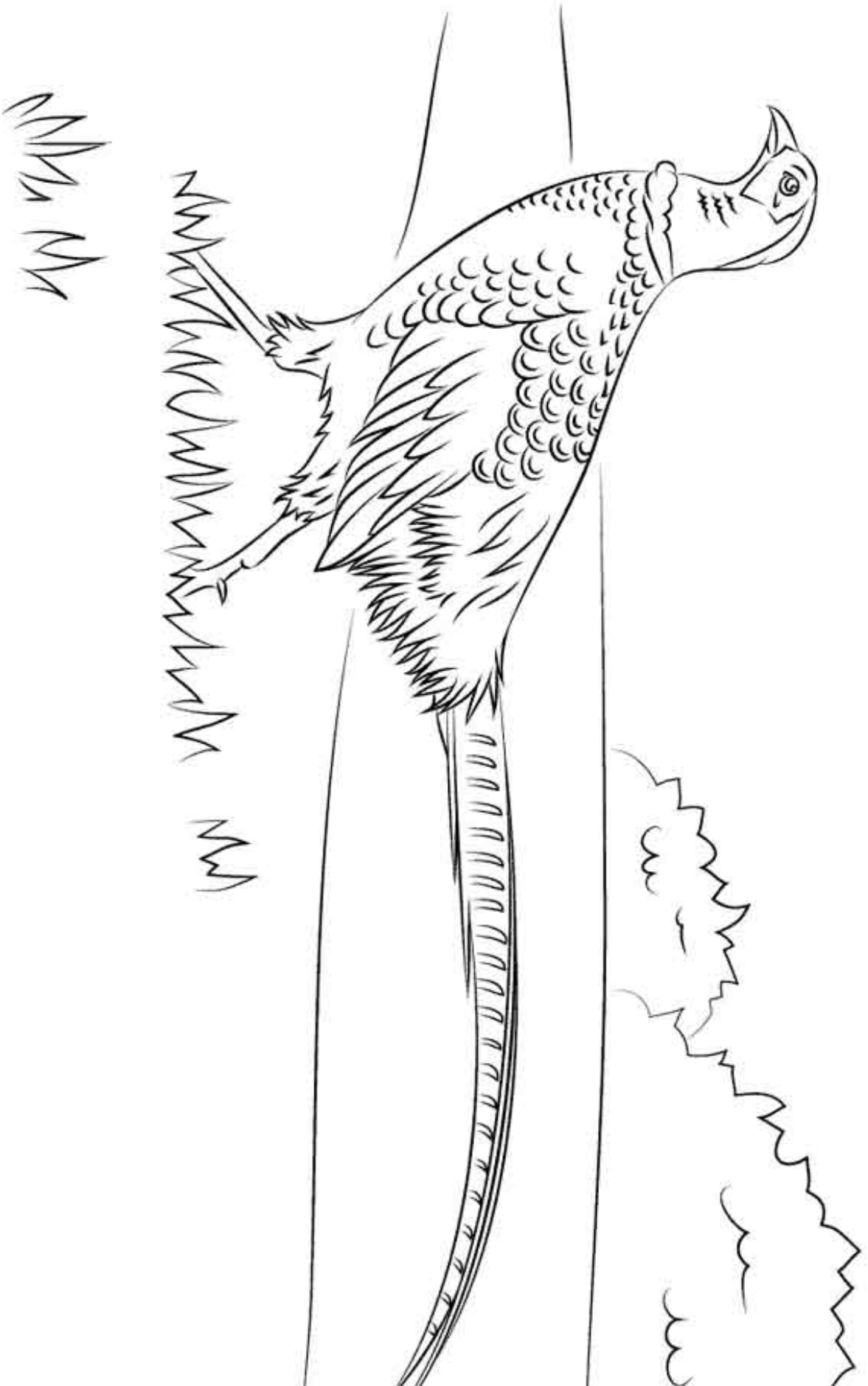

## Learn a little Welsh...

Impress the people you are staying with by learning a little bit of Welsh.

Welsh can be tricky to learn as some of the letters sound very different from how they would sound in English.

<u>English</u>	<u>Welsh</u>	<u>Pronunciation</u>
Hello	Sut mai	Sit mae
My name's ....	Fy enw i yw	Vuh an-oo ee yu
Goodbye	Hwyl fawr	Hueyl vowrr
You're welcome	Croeso	Kroy-ssoh
Please	Os gwelwch ynnda	Os gewl-ookh uhn thah
Thank you	Diolch	Dee-olkh
How are you?	Sut ydych chi?	Sit uh-deekh keeh?

Have you seen any Welsh words whilst you've been staying here? Next time you go out, see if you can spot the word 'Araf' on the roads. This means 'slow-down'.

Write down any others you've seen in the space below and then look them up when you get home.



## Make a traditional Welsh Rarebit (easy!)

Here's a simple recipe for you to try. You might need the help of an adult.

### Ingredients

4 slices of bread

2 tsp Worcestershire sauce, if you like

225g grated, hard cheese like  
Cheddar, Caerphilly or Double  
Gloucester

1 level tsp mustard, if you like

2 tsp flour

1 tbsp butter

Shake of pepper

4 tbsp milk (or beer!)

Pre-heat the oven: fan 140 °C or electric 160 °C: Gas 3

- Put the cheese, butter, Worcestershire sauce, mustard, flour and pepper into a saucepan.
- Mix well and then add the milk or beer to moisten.
- Stir over a gentle heat until all is melted. Stop stirring when it becomes a thick paste.
- Leave to cool for a few minutes while you toast the bread on one side (if possible).
- Spread the rarebit paste over the untoasted side and put under a hot grill until it starts to bubble and go brown in places. Doesn't that smell good! Make sure you let it cool down a bit before you eat it.





## Make a sheep, or your own flock of sheep

1. Colour in the sheep.
2. Glue the sheep onto a piece of thin cardboard, such as the inside of a cereal box.
3. When the glue has dried, cut along the dotted lines.
4. Fold in half along the solid line, so that your sheep stands up.
5. If you want to you could draw a picture of a field or farm on the rest of the cereal box and use it as a background for your sheep. Or use it to make more sheep by copying this one!

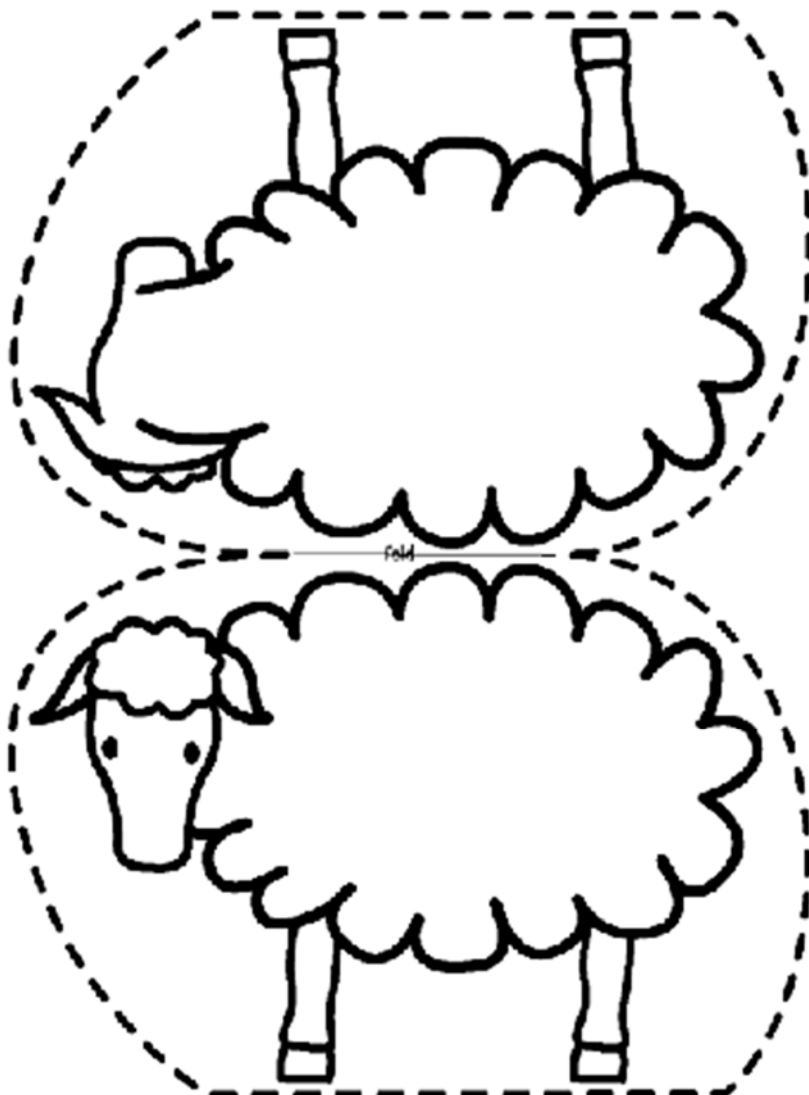



Colour in this picture of a medieval scene.



