



Find out about Dolbelydr's past...

Hello! Welcome to **Dolbelydr** (say *Dol-bell-ee-deer*). I'm Will and I'm eleven years old. It's 1600 in my time - this house is about 440 years old! I live here at Dolbelydr and work in the stables, mucking out and grooming the horses. I have lots of little brothers and sisters but they all live at home with our Mam and Dad just along the Vale of Clywd, or as we call it in Welsh: Dyffryn Clwyd.

This house is so new and big - it's a grand **manor** house and the people who own it are really clever. My family house is nothing like this; it's what you might call a **hovel**. At home, we just manage to get by, so my Mam was very pleased when I got a job helping Bryn, the head groom, here in the stables.



This is the front of Dolbelydr. I'd never seen such a big house before I came here.

It has really tall chimneys, doesn't it? Bryn told me it's because the house is so deep in the valley, so the chimneys have to be tall to draw the smoke away.

Fact:

A **manor** is a large country house with land, a **hovel** is a small, very humble house, some people might call it a dirty hut.

The family who live here are very clever. They are called Salesbury. They all spend a lot of their time in the **solar** – that's the big room on the first floor, which is private for the family reading and writing: in Welsh, English and Latin. I don't know any Latin and I don't know how to read and write. Bryn says I'm quick at picking things up though, that's because if I don't do what he says straight away he gives me a cuff round the ear!

Bryn says that one of the grown up sons, Henry Salesbury, who visits, is writing a book about how you make Welsh words into sentences! He's writing it in Latin and it's the first time anyone has put down how the Welsh language works. Bryn says this is called 'grammar'.



Listen carefully..... It's very quiet here. Maybe that's why Henry can get on and write? It can be very noisy in the stables when we're busy though, especially just before there's a big feast when all the ladies and gentleman arrive on horseback. Otherwise, this place is peaceful and quiet. I've seen deer, rabbits, foxes, badgers, mice and all manner of birds, especially if I go down to the River Elwy. Sometimes my friend Owen and I go fishing, though we don't usually catch much.

What animals and birds have you seen in the fields and woods around Dolbelydr?

Jot them down here. .

-
-
-
-

Fact:

Self-sufficient means that we don't need any outside help to look after ourselves. We can grow enough food to feed ourselves

Do you grow any veggies at home? Perhaps you use an allotment or a back garden or yard.



Deer



Badger

There aren't many other houses round about, so we are **self-sufficient** and look after ourselves. There are lots of little sheds and barns around the main house where the animals live, and a laundry where all the washing is done. We eat the vegetables that are grown here. They are made into soups and stews but quite often, we have meat too! I like venison best – that's deer, have you ever tried it?

I hope that you'll have a good time staying here at Dolbelydr. In some ways, it's not much different from when I knew it in 1600!

Fact:

In Welsh, Dolbelydr means 'Meadow of the Rays of the Sun'.

Unruly Rulers

Who were the Tudor kings and queens?

This lot were a blood thirsty bunch, always chopping off heads. **Tudor** is the family name of the kings and queens. The first Tudor was Henry VII in 1485 and they lasted till Elizabeth I. Then the Tudors' cousins, the Stuarts, ruled from James I to Anne.



King Henry VII
1485
He defeated bad King Richard and became the first Tudor king. Hooray!



King Henry VIII
1509
6 wives, only 1 son. Angry at the Pope horrible Henry made himself Head of the Church destroying all the Catholics churches.



King Edward VI
1547
Henry VIII's only son, he had some big shoes (and clothes) to fill! King at nine and dead at 16. Poor Eddie.

Lady Jane Grey
1553
Only 16 when she became Queen for just 9 days before Mary Tudor took the throne. Off with her head!



Queen Mary I
1553
Back to Catholics again. Bloody Mary was her name, burning Protestants was her game.

Queen Elizabeth I
1558
Good Queen Bess knew leaving religion alone was best. (Unless the Catholics attacked!) Had lots of boyfriends but married none.





Meet Queen Elizabeth I

– who ruled when Will lived at Dolbelydr.



Hi Lizzie!

So when did you become queen?

I became Queen on 17 September 1558 when I was 25.

What are you most famous for?

I defeated the Spanish Armada that tried to invade England in 1588. How dare they?

What is your favourite thing to do?

I loved having a bath and being clean, I have 4 baths every year! I was the cleanest woman in England. And I LOVE sweets.

What is the naughtiest thing you've ever done?

I pretended to be a Catholic when my half-sister bloody Mary was queen; once she was dead I turned England Protestant again!



What does Dolbelydr look like?

Can you walk all the way around it?

Can you use any of these words to describe the building? Draw a circle around the ones that apply. Use the dictionary on the bookshelf to look up the meanings of any words you're not sure of.

A castle	Tall
Pretty	Industrial
Stone	Brick
Symmetrical	Humble
Square	Elegant
Flamboyant	Friendly

Dolbelydr is a stone building with a timber frame. **Dendrochronology** (say *den-drow-kron-ol-ogee*) carried out on the timbers in the building dates it to around 1578 – that means it's over 440 years old!

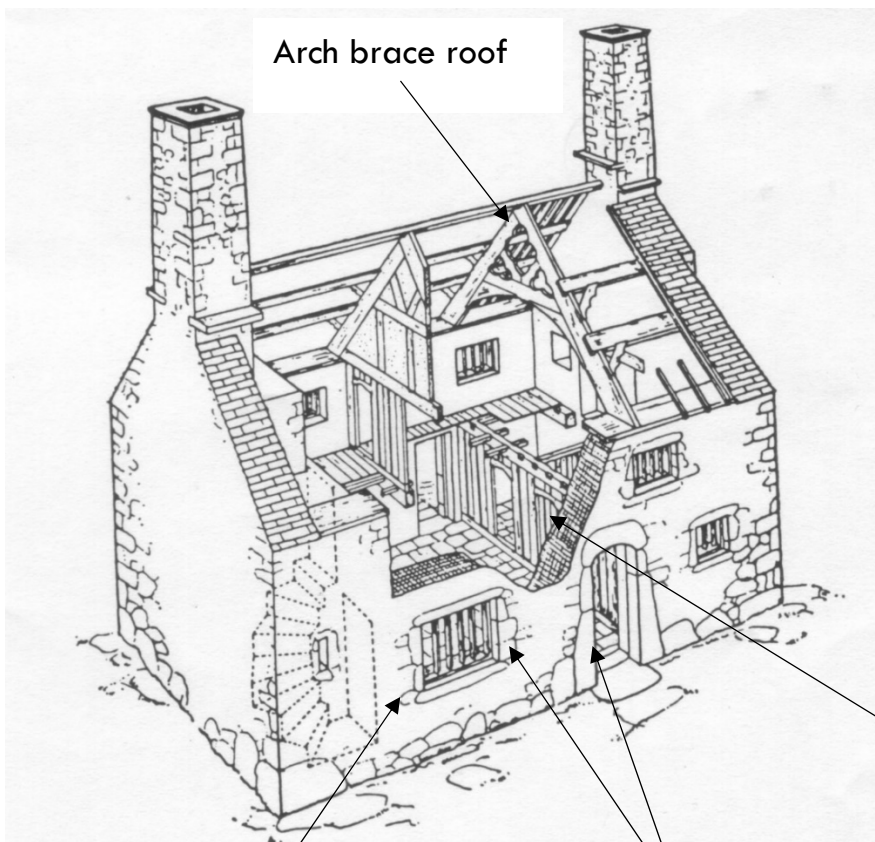

Fact:

Dendrochronology is the science of dating something by the wood it's made of. Normally you count the growth rings in timber and tree trunks. Each ring is a year: in wet years the tree grows faster than in dry years.

Have you ever counted the rings on a branch or tree stump to see how old the tree was? It's the same technique!

Plank and muntin screen – wooden screens which divided living areas

Timber **mullioned** (say *mull-ee-yond*) windows. A mullion is the name for the vertical parts that divide the window

Quoins (say *koy-ns*) – to strengthen door and window openings



Buildings are quite easy to draw. They are usually made up of lots of geometric shapes, like squares, triangles and circles.

Have a go at drawing the front of Dolbelydr.

Please tell an adult where you are going so they don't worry about where you are!

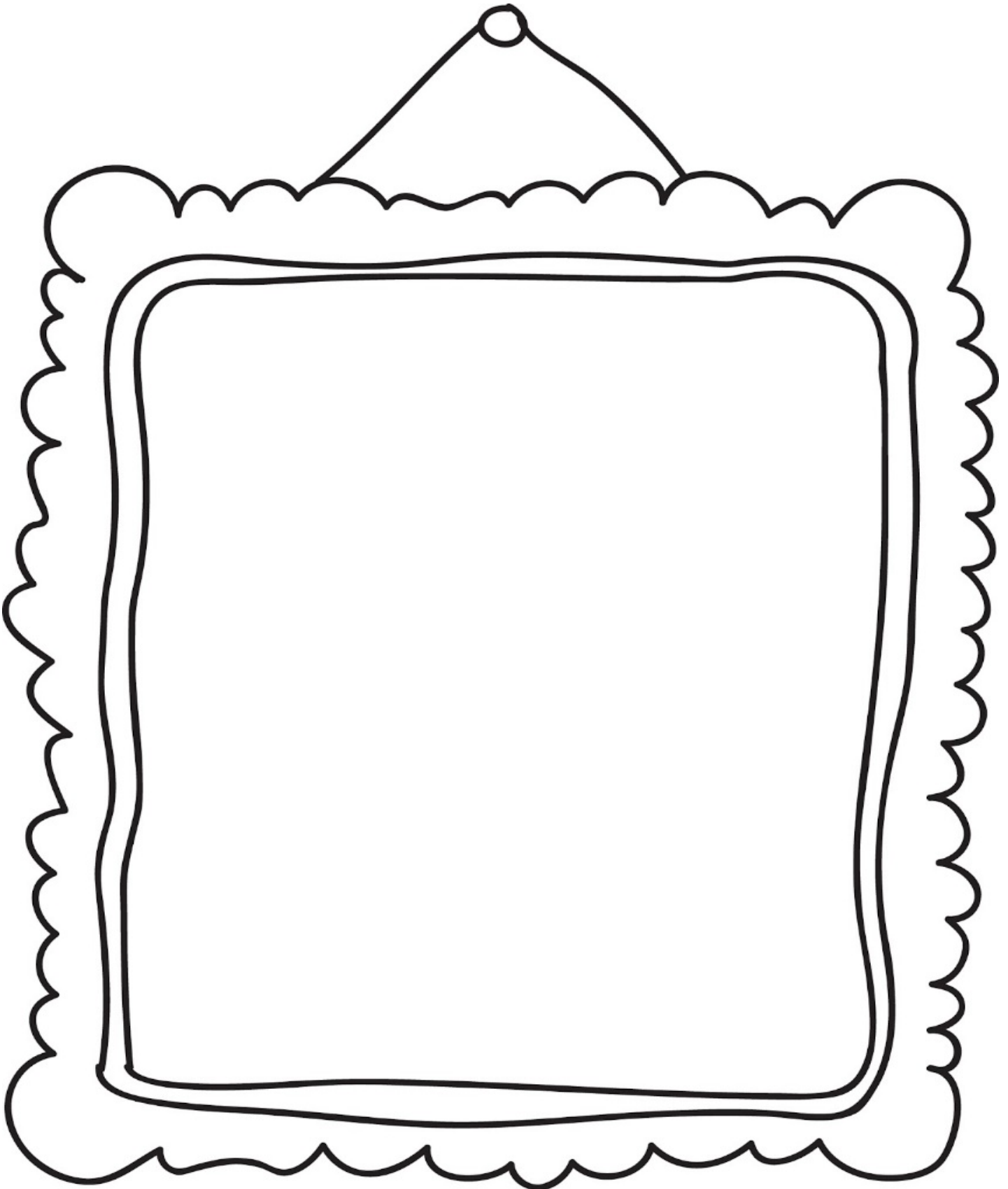



What is Dolbelydr built from?

Fact:

Some buildings were built from stone that was dug out of the ground when farmers ploughed the fields, other buildings were made from stone that was quarried and cut into neat shapes and sizes. There are still many stone quarries around the country today, where people get stone out of the ground.

Stone buildings were once cheaper to build than brick ones. Once we could transport bricks up and down the country on the canals and railways, brick buildings become cheaper and more popular – but stone still looked smart!

Stone is the solid foundation of the earth. It exists as huge mountains, rocks, stones or small pebbles washed smooth by water. There are many different types of stone, with different colours and textures. Some are better to build with than others. Dolbelydr is made from limestone.



When Dolbelydr was built, stone was taken out of the ground by hand. Today, a quarry is a place where stone is blasted out of the ground with explosives! The one in the picture shows what quarries look like now.



People who work with stone are called stonemasons. They build walls, carve the stone into shapes or add patterns to its surface. They use a mallet and special tools called chisels to shape the stone. The picture on the left shows a stonemason hard at work.

Mallet



Chisels





What other building materials can you find outside and inside Dolbelydr?

- | | |
|-------|----------|
| Stone | Glass |
| Wood | Plastic |
| Metal | Clay |
| Flint | Concrete |
| Brick | Ceramic |

Circle what you can see and note down where you found them.

The size and shape of windows tells you a lot about the age and style of the building. What type of windows does Dolbelydr have?

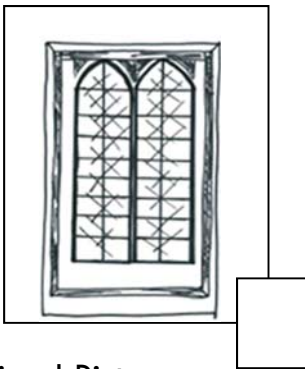

Fixed Picture

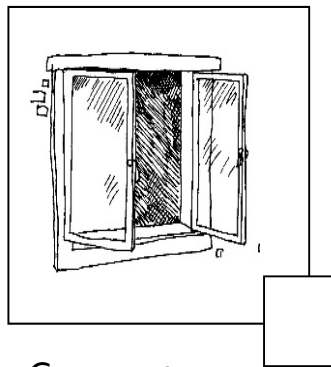

Casement

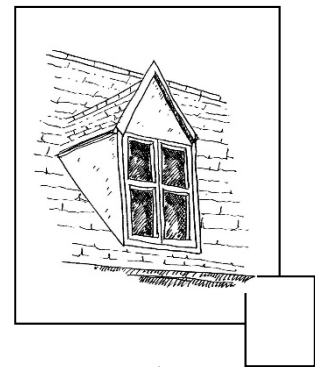

Dormer or Attic

Fact:

The windows at Dolbelydr are timber framed, that means they're made of wood, but they've been painted to look as if they're made of stone. These windows are the ones that were made when Dolbelydr was built but of course, they have been carefully restored.

There are many different styles of staircases. Which style is closest to the staircase at Dolbelydr? Have you found the secret staircase?

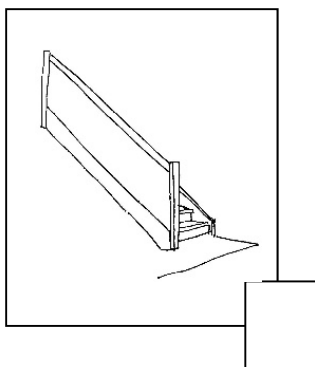

Straight

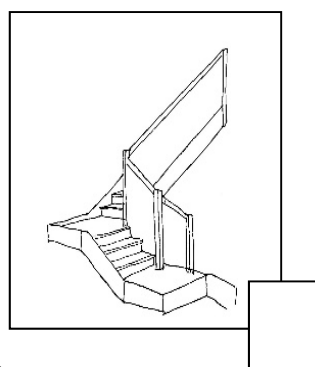

Quarter turn or dog leg

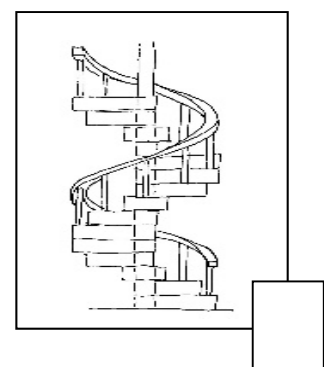

Spiral

Quest



Discover more about Dolbelydr

Dolbelydr has stood here for about 450 years! During that, time things have changed inside and outside the building. Follow this Quest to discover more about it.

Can you find this green painted screen in the kitchen?

Yes, it's above the cupboard on the left hand side of the fireplace. Count how wiggly columns there are and put the number in the box.



What weighs more than 10 adult elephants..?

You'll never guess... it's Dolbelydr's roof! The roof is made of huge stone tiles and weighs over 30 tons - wow!

Have you found the garderobe?

A garderobe is a medieval toilet – they were very different to modern toilets – just a seat over a long chute where your poo would plop into a moat, or at Dolbelydr, a pit... eww! If you go outside, you might be able to find the pit where the waste used to go!



Search for the soldier...

This may take you a while... see if you can find this soldier scratched into the wood panelling? Hint: it's by a doorway!

This soldier, and what is thought to be his wife were scratched into the wood in the early 19th century – naughty!

Pssst!Have you found the secret staircase yet? Look carefully in the kitchen.



Living in Dolbelydr

The floorplan of a building is a map of the rooms. Dolbelydr has three floors. The plans below show you the shape of each room. Take a walk around each floor. Write on the plan what each room is used for. Mark the bedroom you are sleeping in with a star. ★

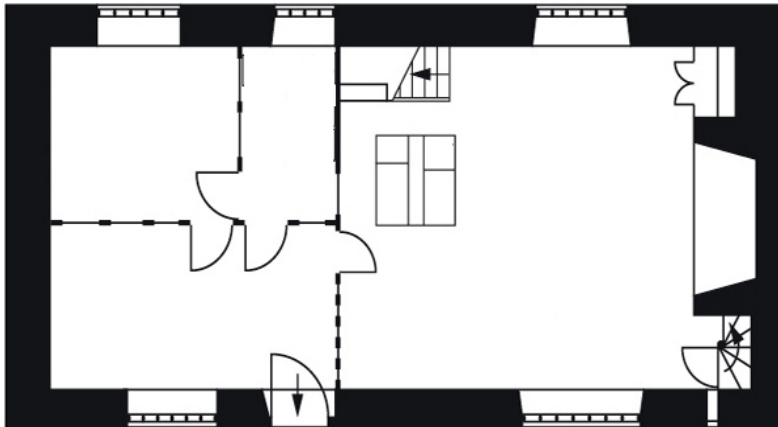

Ground floor

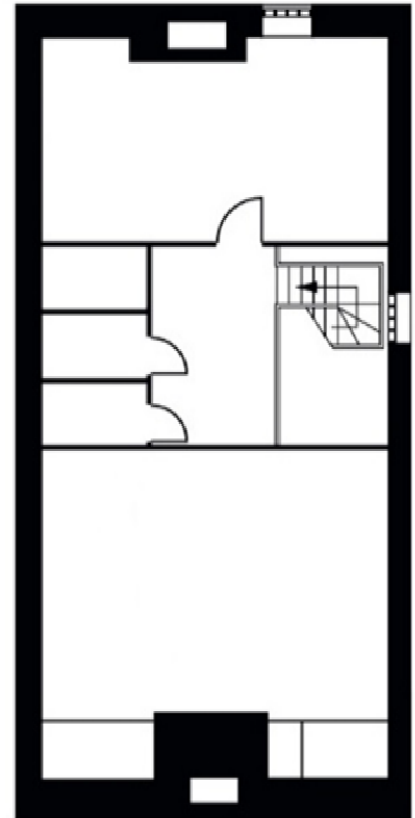

Second floor

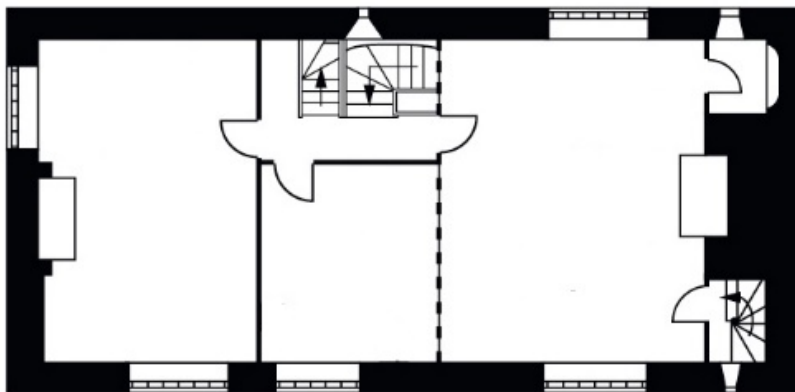

First floor

We use these symbols to show where beds, tables and bathrooms are. Draw the symbols on to the floorplans to show where the furniture is.



Bed

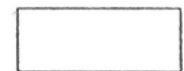

Rectangular (or a round) table



Bathroom



Cooker

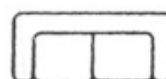

Sofa



Kitchen sink



Can you find an example of each of these things inside Dolbelydr? Describe, or draw the object when you find it.

Your favourite chair

The fireplace (is it an open fire or does it have a stove?)

Draw the pattern of a rug on the floor

In the box below, draw the view from your favourite window. What can you see in the distance? Are there any animals in the fields?

A large, empty rectangular box with a black border, intended for drawing a view from a window.



Can you answer these questions correctly? To find the answers skip a page...

1. When was Dolbelydr built?

Fifty five years ago About four hundred & fifty years ago Over five thousand years ago About one hundred and fifty years ago

2. What is the name of the nearby river?

River Elwy River Wye River Severn River Dee

3. What are the window frames made of?

Stone Brick Wood Cement

4. Who was on the throne when Will lived here?

(Psst... check Unruly Rulers!)

Henry I Elizabeth II Henry IV Elizabeth I

5. Which room was used for the family's private living quarters in Will's time?

Attic Kitchen Hall Solar

6. What kind of a building is Dolbelydr?

Barn Skyscraper Manor house Hovel

7. What animal are you unlikely to see around Dolbelydr?

Sheep Deer Rabbits Kangaroos

8. What stone is Dolbelydr made from?

Marble Sandstone Limestone Granite

9. What shape are the panes of glass in the windows?

Pentagons Diamonds Triangles Kites

10. What is a garderobe?

A knight A medieval toilet A dance A weapon



Dolbelydr Word Search

Now have a go at the word search. The words to find are at the bottom of the page. Watch out, they may go forwards, backwards, horizontally, vertically or diagonally!

R	A	Y	S	O	F	T	H	E	S	U	N
D	Y	W	L	C	F	O	E	L	A	V	W
Y	E	L	L	A	V	O	S	L	O	U	E
L	R	I	V	E	R	O	A	D	L	I	L
E	L	W	Y	U	L	E	B	E	A	M	S
B	S	W	N	A	D	E	N	B	I	G	H
L	E	L	R	E	B	M	I	T	L	E	N
O	N	A	A	O	L	R	S	K	L	A	W
D	L	S	M	T	D	T	K	F	U	O	O
A	E	L	H	S	E	U	R	E	O	D	D
L	E	E	A	E	R	R	T	D	Q	S	A
O	R	V	R	H	E	A	S	A	N	T	E
S	T	O	N	E	I	P	R	O	N	A	M

HALL	SHEEP	WELSH	DOLBELYDR
SOLAR	DEER	TUDOR	VALE OF CLWYD
TIMBER	VALLEY	MANOR	RIVER
BEAMS	WOODS	MEADOW	ELWY
STONE	WALKS	RAYS OF THE SUN	DENBIGH

How many of these words did you find? Put your score in the box.



Answer sheet:

Quiz answers:

1. About four hundred and fifty years ago.
2. River Elwy
3. Wood
4. Elizabeth I
5. The solar
6. Manor house
7. Kangaroos
8. Limestone
9. Diamonds
10. In the 2000s

How many did you get right?

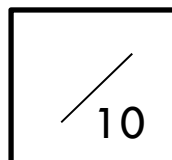

Pheasant Facts:

Common pheasants are bred to be shot during the shooting season, October 1 to February 1. They were brought to Europe from Asia many centuries ago.

Over the page, there is a picture of a pheasant (say *fez-ant*).

Why not look up the pheasant in the Bird Book in the Landmark bookcase to copy the colours? The male bird is colourful in order to attract a mate. You might see him surrounded by a group of females who are a dull brown colour.

Have you seen any pheasants during your stay?

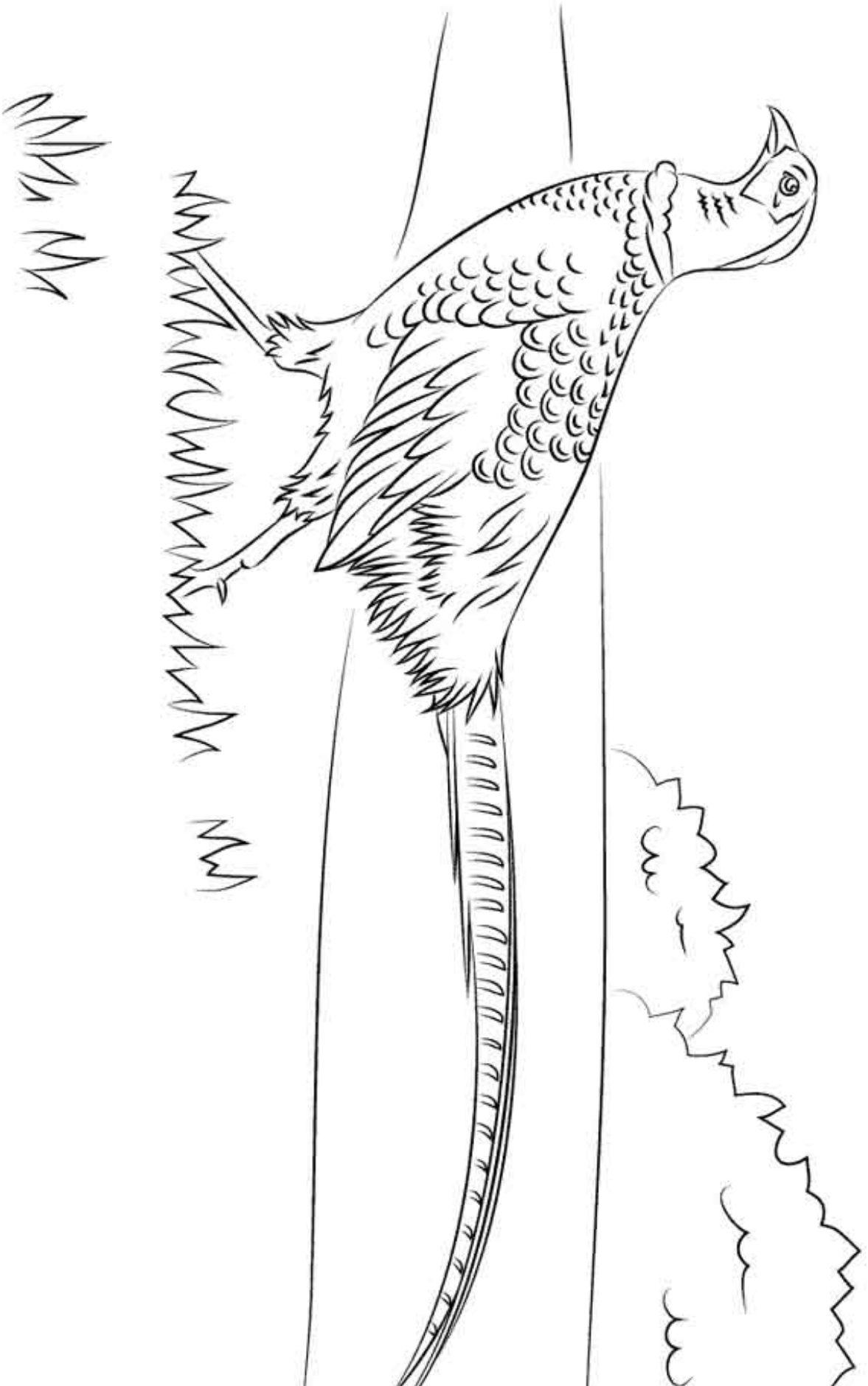

Design a curtain:

Go and look at the curtains in the sitting room. They have been screen-printed- perhaps you've done some printing at school? The design of the curtains is based on the title page of Henry Salesbury's famous book, *The Grammatica*!

In the little boxes at the bottom of the page, you could draw these curtains; in the big boxes, you could invent a pattern for your own curtain. Curtain designs have to be repeated next to each other, so your design needs to be repeated identically in each box. Think about how the pattern touches the next repeat!

--	--

--	--



Bake some welsh cakes

Welsh cakes, also known as 'bakestones' because they used to be cooked on hot stones, have been popular in Wales since the 19th Century. They were the perfect size to be popped into a working man's coat pocket as a snack.

Here's a simple recipe for you to try. You might need the help of an adult.

225g plain flour

50g cubed butter

85g caster sugar

50g cubed lard

½ tsp mixed spice

50g currants

½ tsp baking powder

1 egg, beaten

Splash of milk

- Put the flour, sugar, mixed spice, baking powder and a pinch of salt into a bowl.
- Add the butter and lard and rub between your fingers until it makes breadcrumbs.
- Add the currants and then tip in the beaten egg. Work the mixture until you have a soft dough (say 'doh'); add a splash of milk if it seems too dry.
- Roll the dough out onto a lightly floured surface until it is about a centimetre thick. Cut out rounds using a 6cm cutter.
- Grease a griddle pan or heavy frying pan with some lard and place over a medium heat on the hob.
- Place the welsh cakes into the pan in batches and cook on each side for about three minutes until they are golden, crisp and cooked through.
- Sprinkle with a little caster sugar and enjoy!





Learn a little Welsh...

Impress the people you are staying with by learning a little bit of Welsh.

Welsh can be tricky to learn as some of the letters sound different from how they would in English.

<u>English</u>	<u>Welsh</u>	<u>Pronunciation</u>
Hello	Sut mai	Sit mae
My name's	Fy enw i yw	Vuh an-oo ee yu
Goodbye	Hwyl fawr	Hueyl vowrr
You're welcome	Croeso	Kroy-ssoh
Please	Os gwelwch yndda	Os gewl-ookh uhn thah
Thank you	Diolch	Dee-olkh
How are you?	Sut ydych chi?	Sit uh-deekh khee?

Have you seen any Welsh words whilst you've been staying here? Next time you go out, see if you can spot the word 'Araf' on the roads. This means 'slow-down'.

Write down any others you've seen in the space below and then look them up when you get home.



Colour in this Welsh dragon...

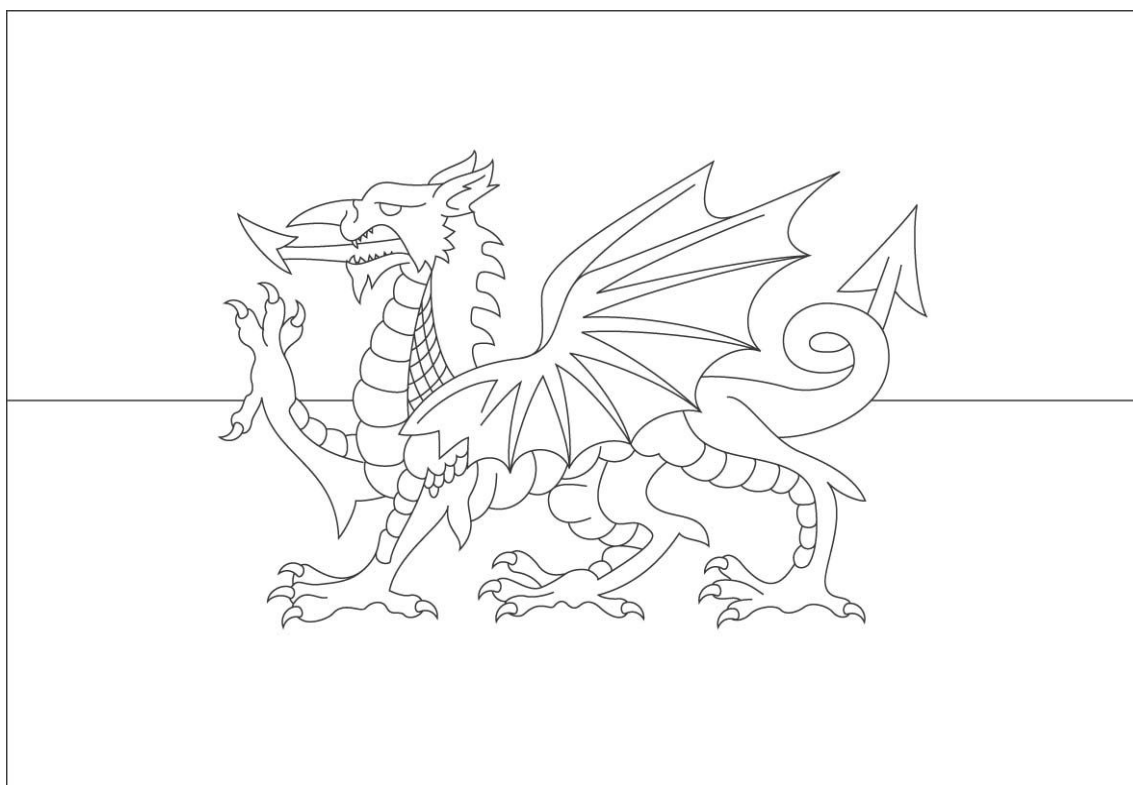

Make a sheep, or your own flock of sheep

1. Colour in the sheep, or perhaps it's a lamb?
2. Glue the sheep onto a piece of thin cardboard, perhaps the inside of a cereal box.
3. When the glue has dried, cut along the dotted lines.
4. Fold in half along the solid line, so that your sheep stands up.
5. If you want to you could draw a picture of a field or farm on the rest of the cereal box and use it as a background for your sheep. Or use it to make more sheep by copying this one!

